

2

1

B

B

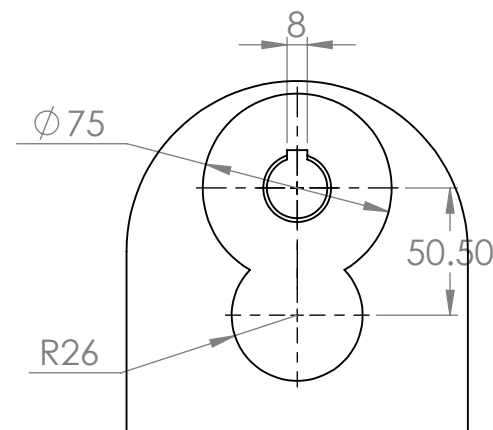
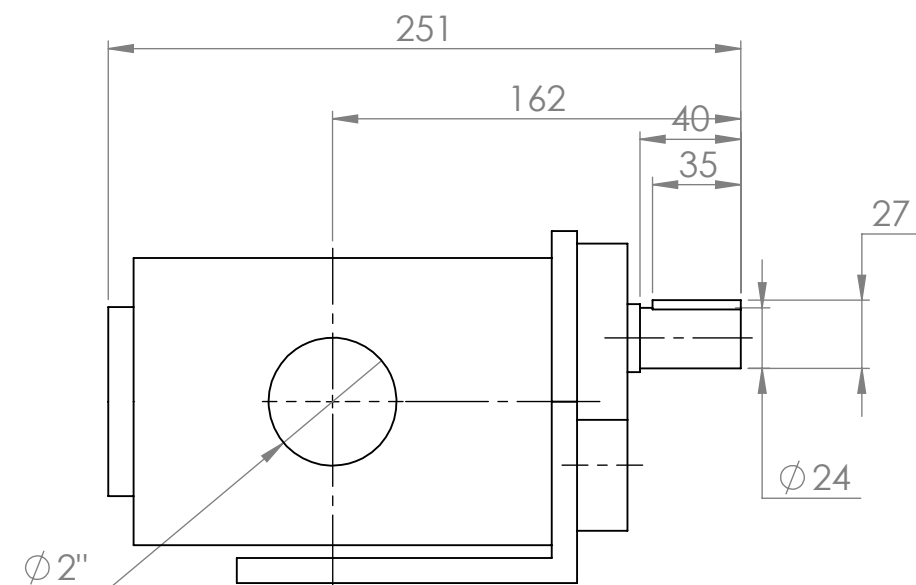
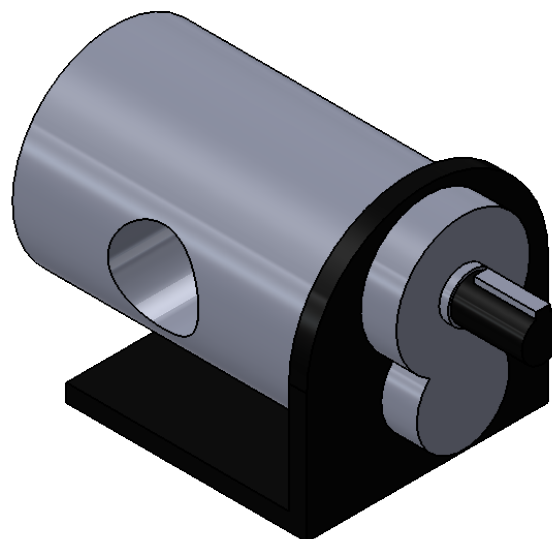

A

A

ALBANY PUMP CO. LTD.

Copyright © 2016 Albany Pump Co. Ltd. All rights reserved. This drawing and the information contained or depicted herein are the sole property of Albany Pump Co. Ltd. Copies are communicated to the recipient in strict confidence and may not be retransmitted, published, reproduced, copied or used in any manner, including as the basis for the manufacture or sale of any products, without the express prior written consent of Albany Pump Co. Ltd..

TITLE:

SIZE

DWG. NO.

200

SSX series 200

SHEET 1 OF 1

2

1