

2

1

B

B

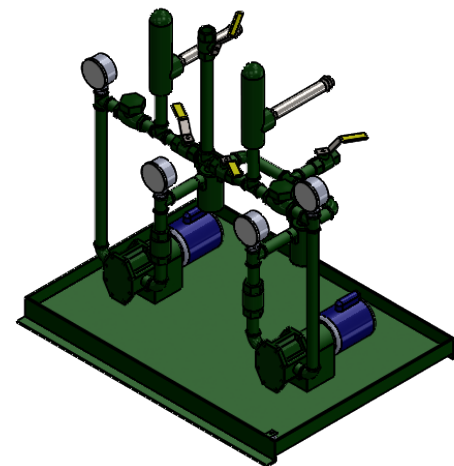
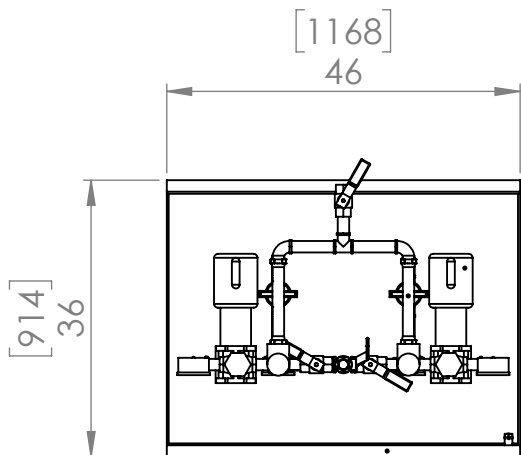

A

A

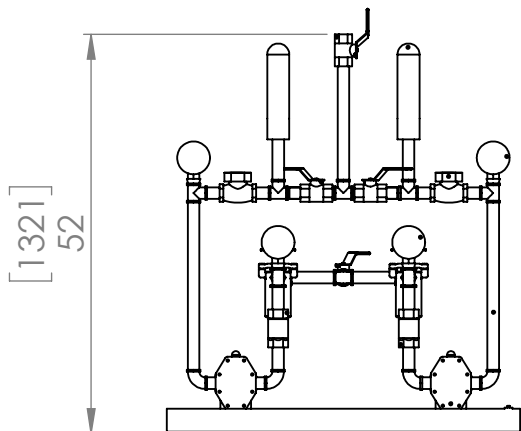

Equipment Adheres to CSAB139 Installation Code for Oil Burning Equipment (2006 & 2015), TSSA Liquid Fuels Handling Code, CSA C282, NFPA 30 Flammable and Combustible Liquids Code, NFPA 31 Standard for Installation of Oil Burning Equipment

ALBANY PUMP CO. LTD.

Copyright © 2016 Albany Pump Co. Ltd. All rights reserved. This drawing and the information contained or depicted herein are the sole property of Albany Pump Co. Ltd. Copies are communicated to the recipient in strict confidence and may not be retransmitted, published, reproduced, copied or used in any manner, including as the basis for the manufacture or sale of any products, without the express prior written consent of Albany Pump Co. Ltd..

TITLE:

SIZE DWG. NO.
25 25 B layout

SHEET 1 OF 2

2

1