

C41 • C51 • C61 SERIES

# Composite Curve (Single Phase)

## C41 • C51 • C61 SERIES (60 Hz ODP Service Factor Motor Horsepower Selections\*) 3450 RPM

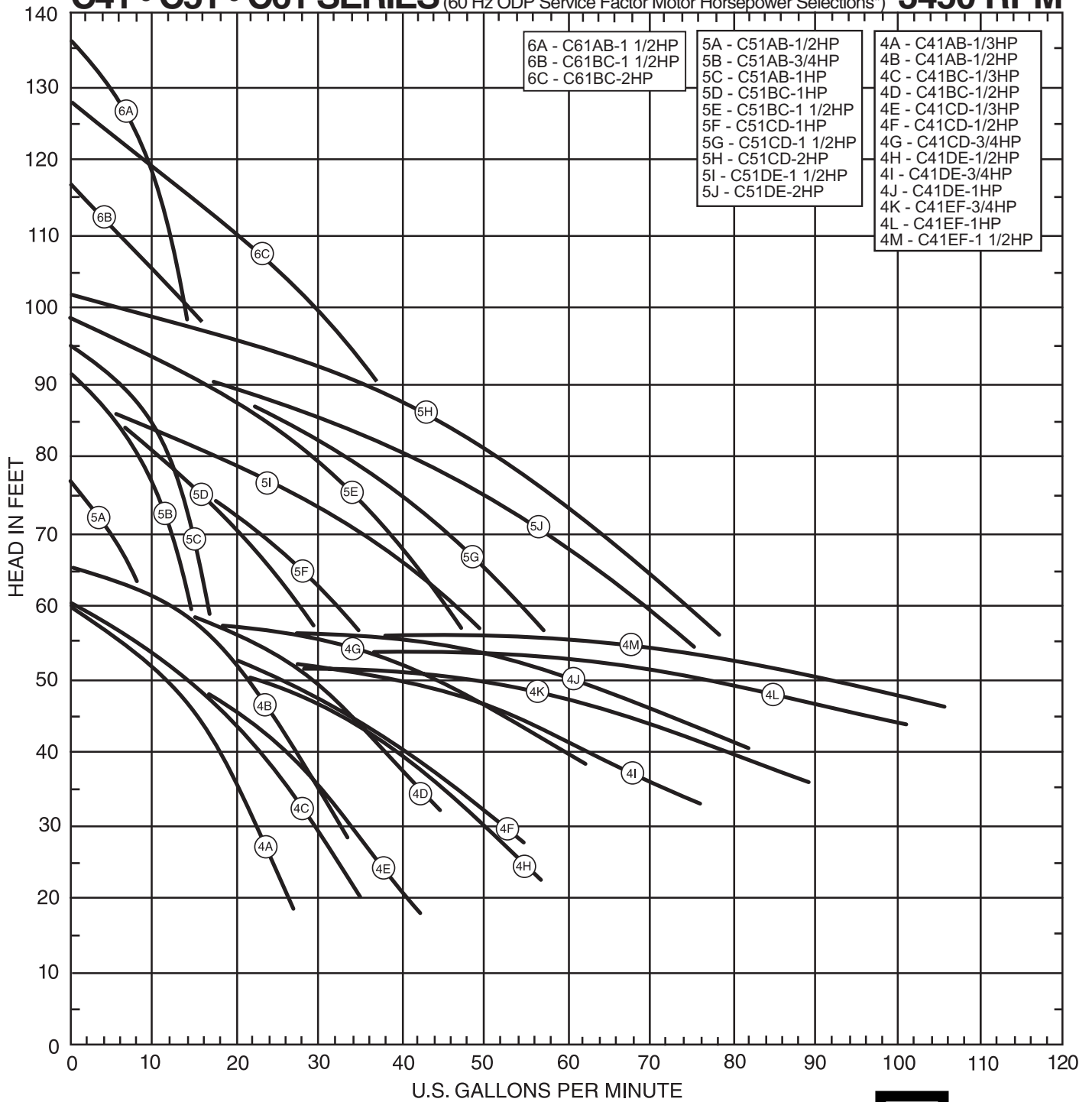

### MTH PUMPS

401 West Main Street • Plano, IL 60545-1436  
 Phone: 630-552-4115 • Fax: 630-552-3688  
 Email: SALES@MTHPUMPS.COM  
 http://WWW.MTHPUMPS.COM

\* Horsepower data is valid for 1.0 specific gravity fluids only (1 Phase)

C41 • C51 • C61 SERIES

# Performance Curves (Single Phase)

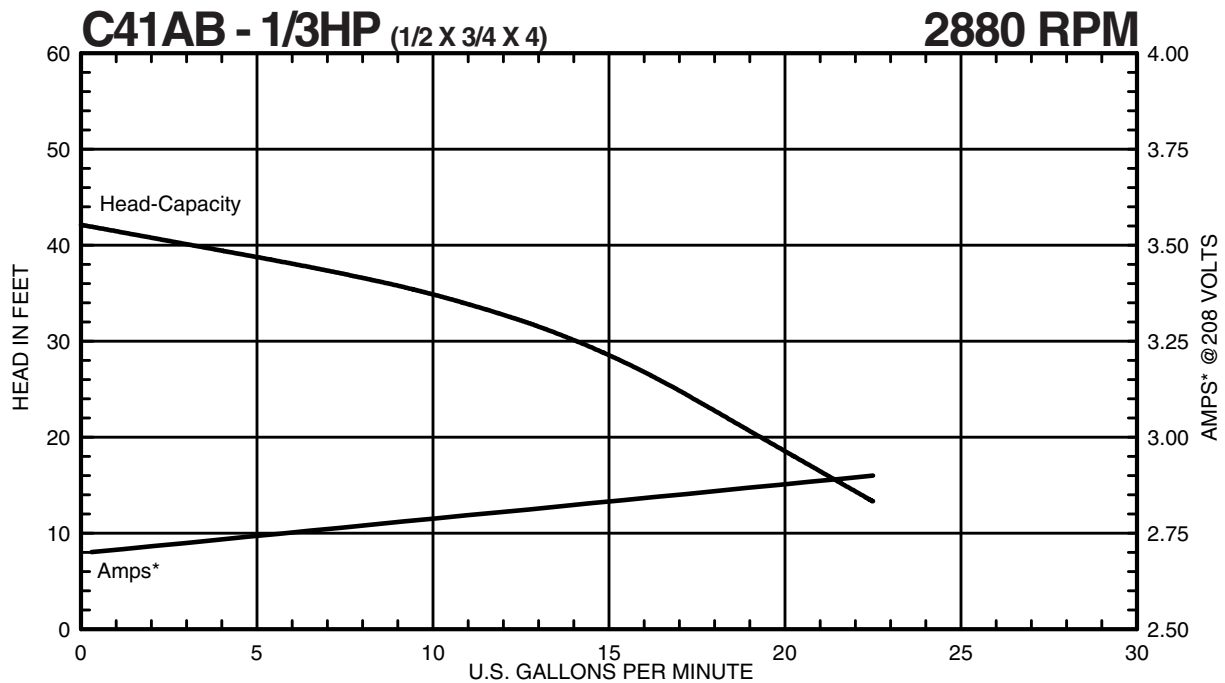
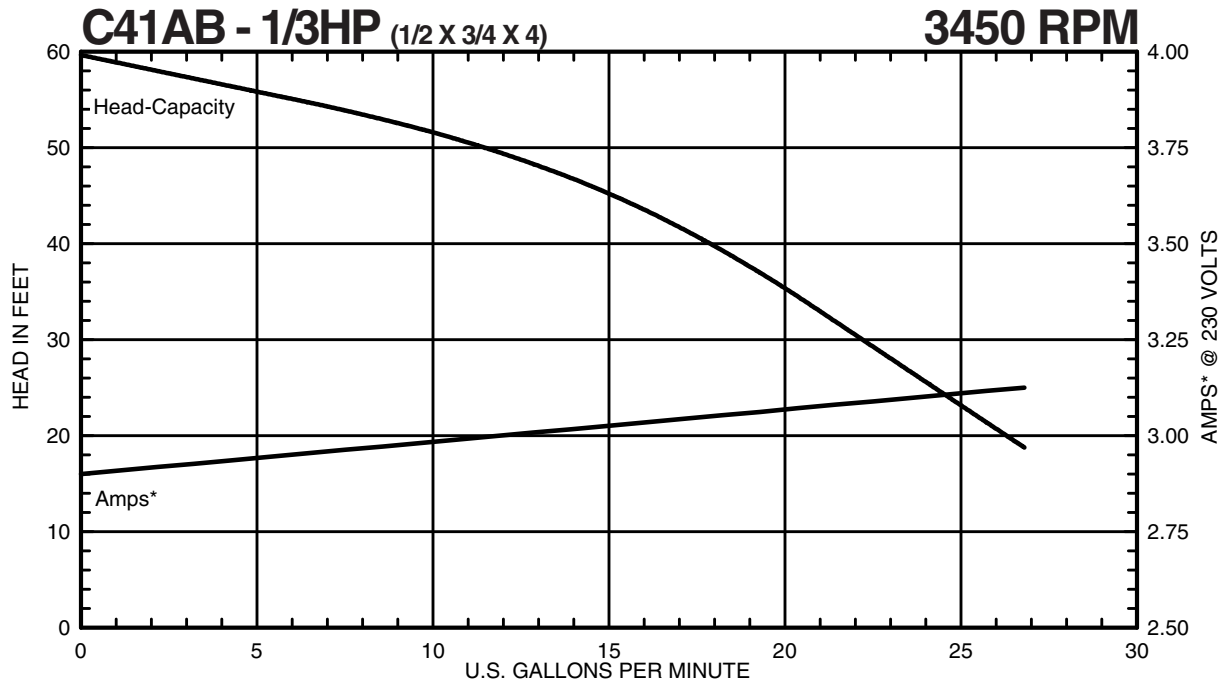

**MTH PUMPS**

401 West Main Street • Plano, IL 60545-1436  
Phone: 630-552-4115 • Fax: 630-552-3688  
Email: SALES@MTHPUMPS.COM  
<http://WWW.MTHPUMPS.COM>

\*Amp and HP data valid for 1.0 specific gravity fluids only (1 Phase)

# Performance Curves

(Single Phase)

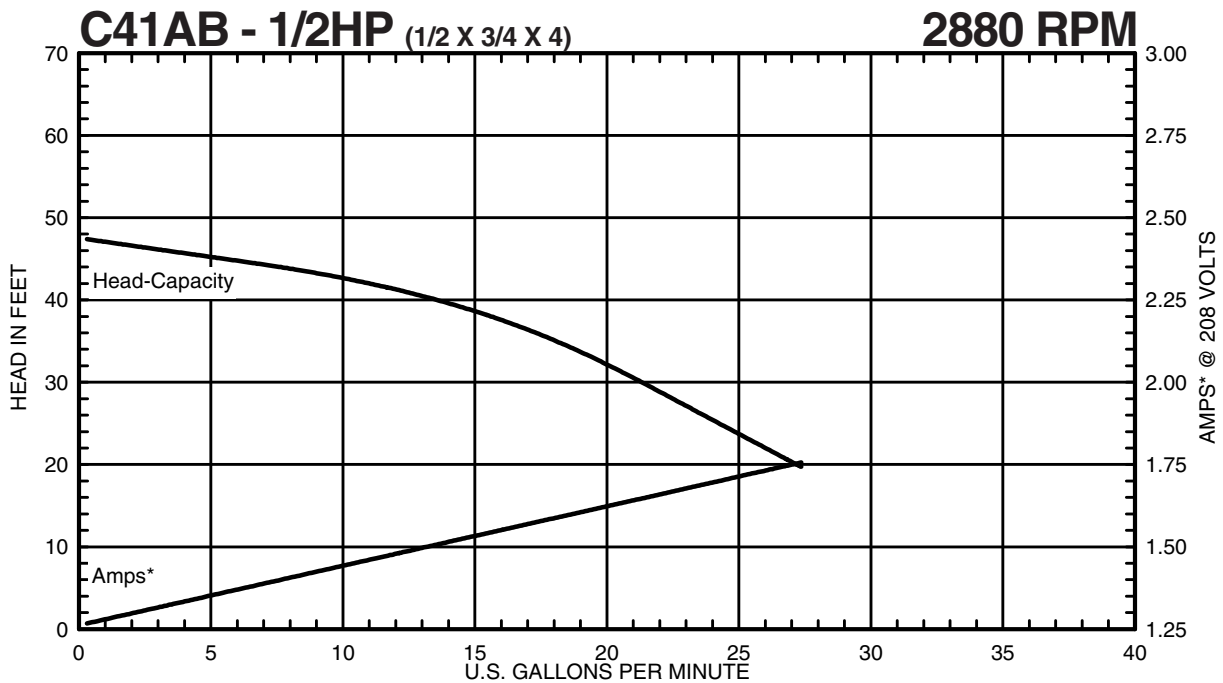
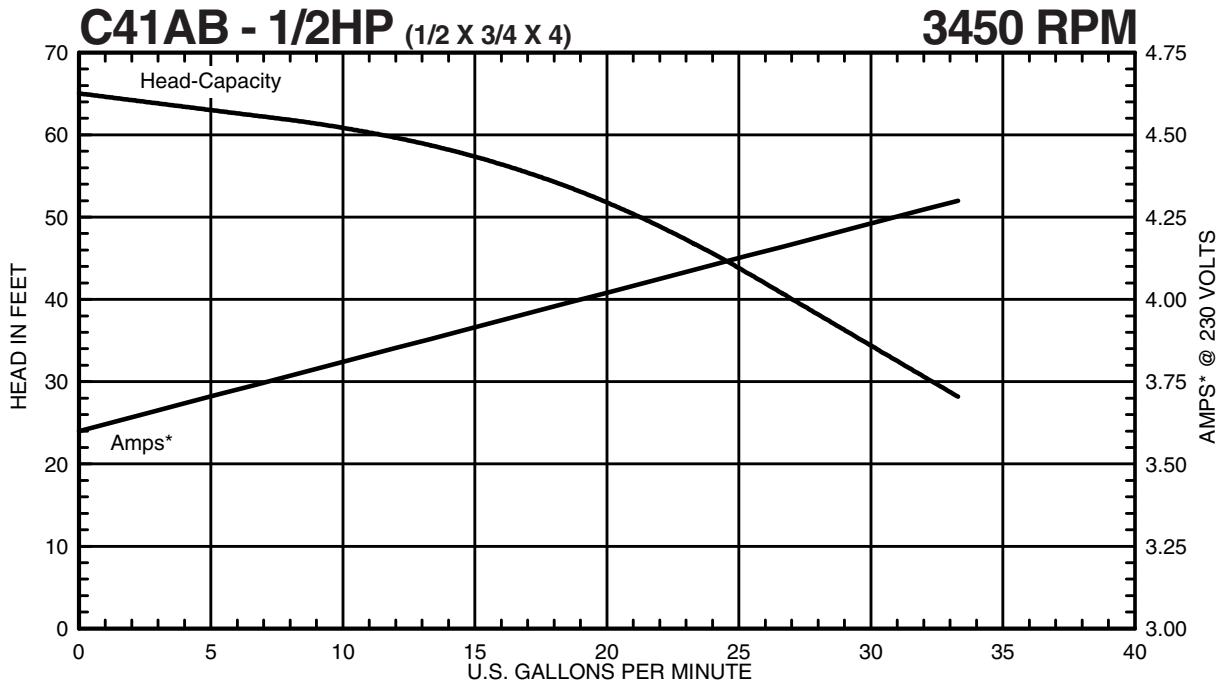

**MTH PUMPS**

401 West Main Street • Plano, IL 60545-1436  
 Phone: 630-552-4115 • Fax: 630-552-3688  
 Email: SALES@MTHPUMPS.COM  
<http://WWW.MTHPUMPS.COM>

\*Amp and HP data valid for 1.0 specific gravity fluids only (1 Phase)

C41 • C51 • C61 SERIES

# Performance Curves (Single Phase)

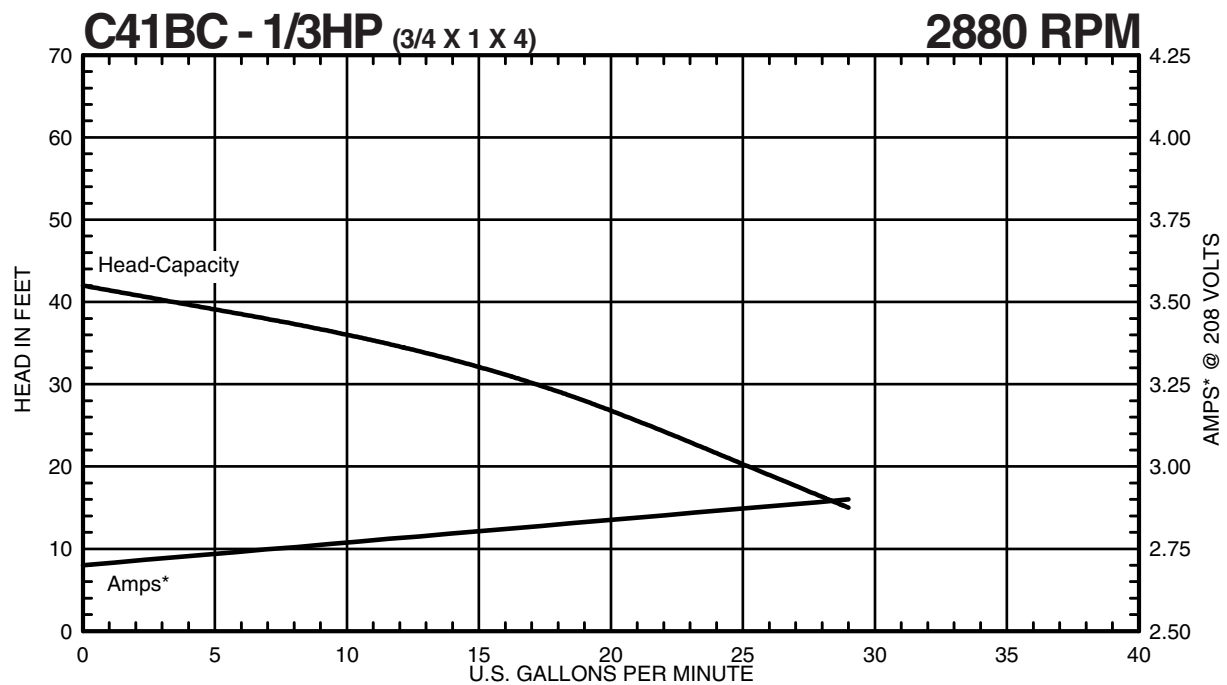
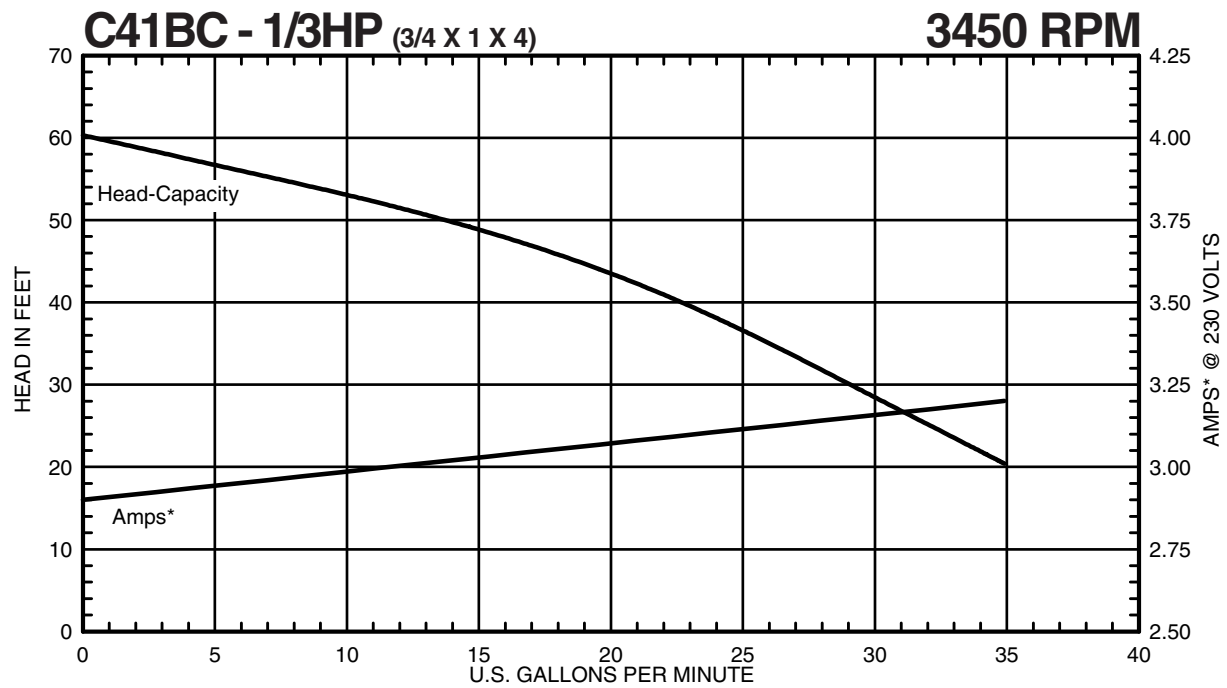

**MTH PUMPS**

401 West Main Street • Plano, IL 60545-1436  
 Phone: 630-552-4115 • Fax: 630-552-3688  
 Email: SALES@MTHPUMPS.COM  
<http://WWW.MTHPUMPS.COM>

\*Amp and HP data valid for 1.0 specific gravity fluids only (1 Phase)

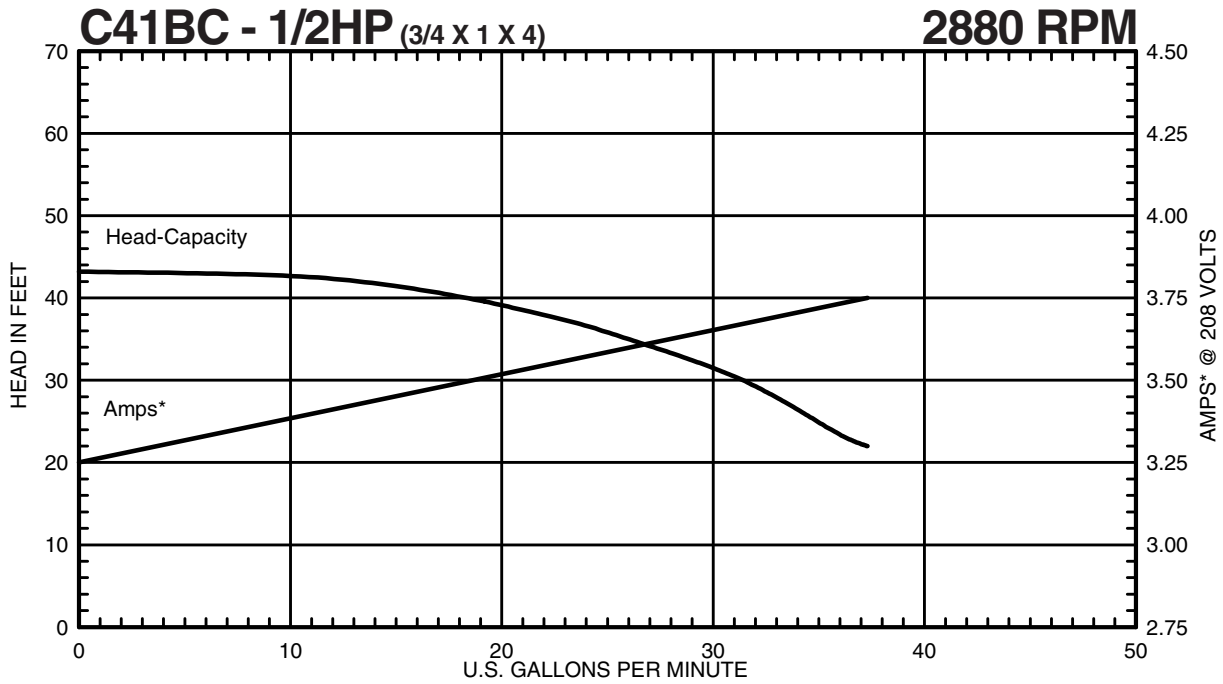
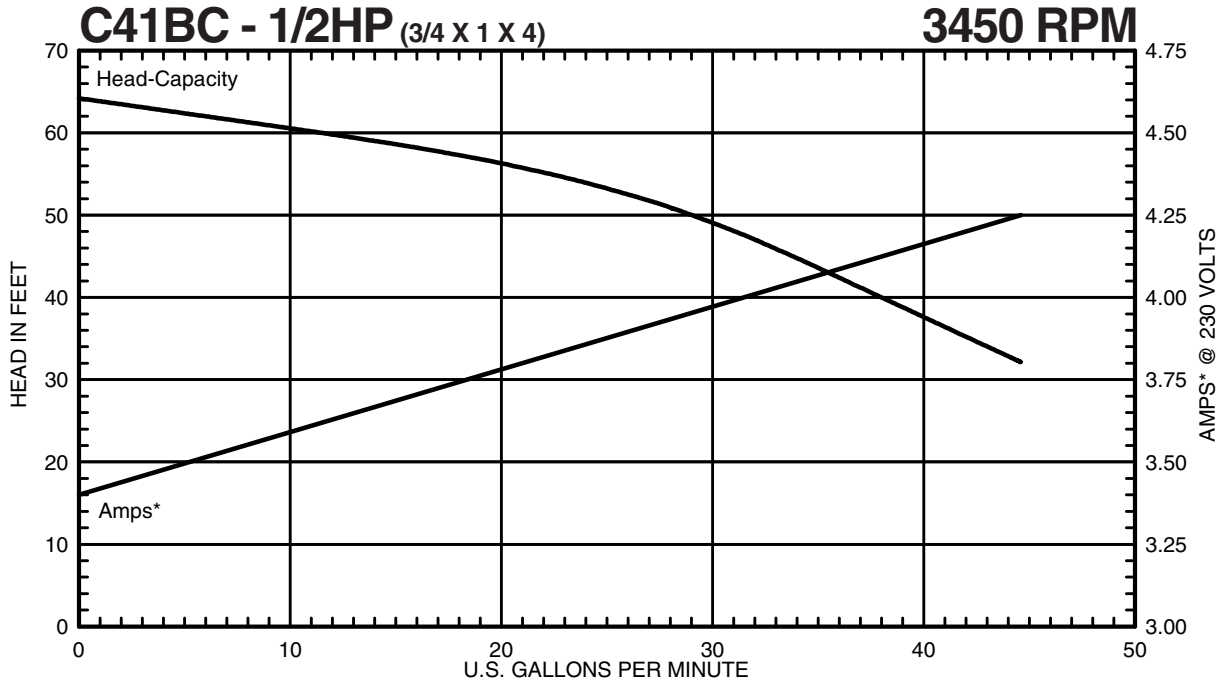

**MTH PUMPS**

401 West Main Street • Plano, IL 60545-1436  
 Phone: 630-552-4115 • Fax: 630-552-3688  
 Email: SALES@MTHPUMPS.COM  
<http://WWW.MTHPUMPS.COM>

\*Amp and HP data valid for 1.0 specific gravity fluids only (1 Phase)

C41 • C51 • C61 SERIES

# Performance Curves (Single Phase)

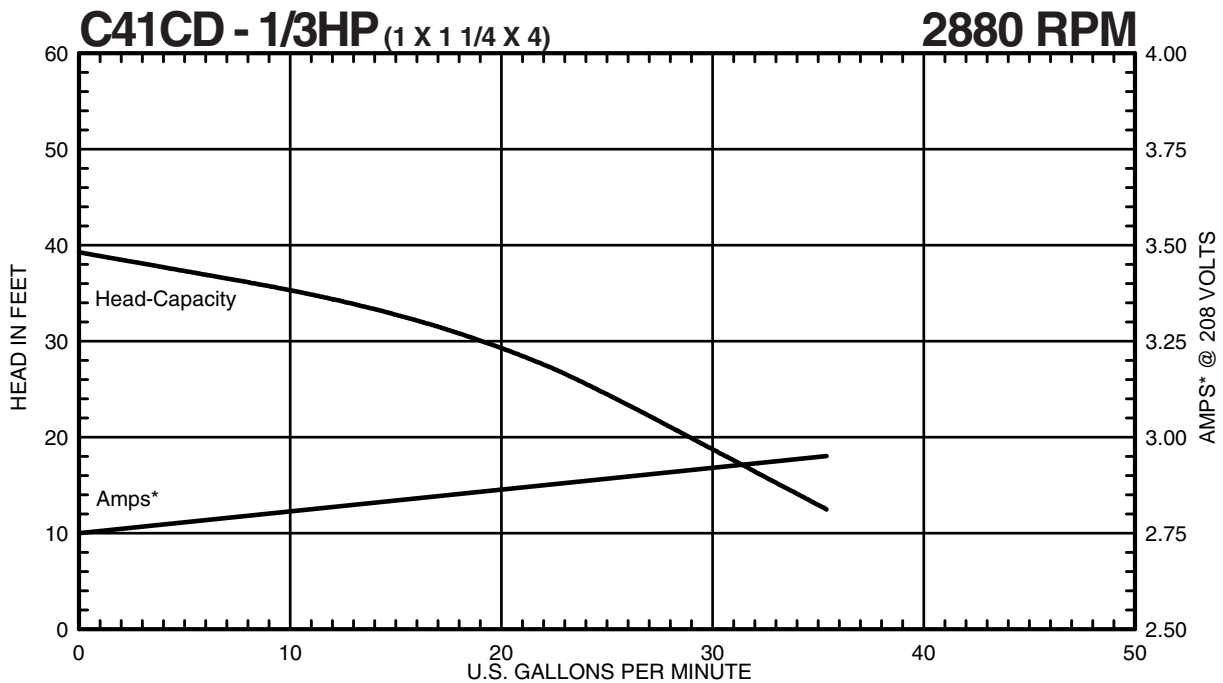
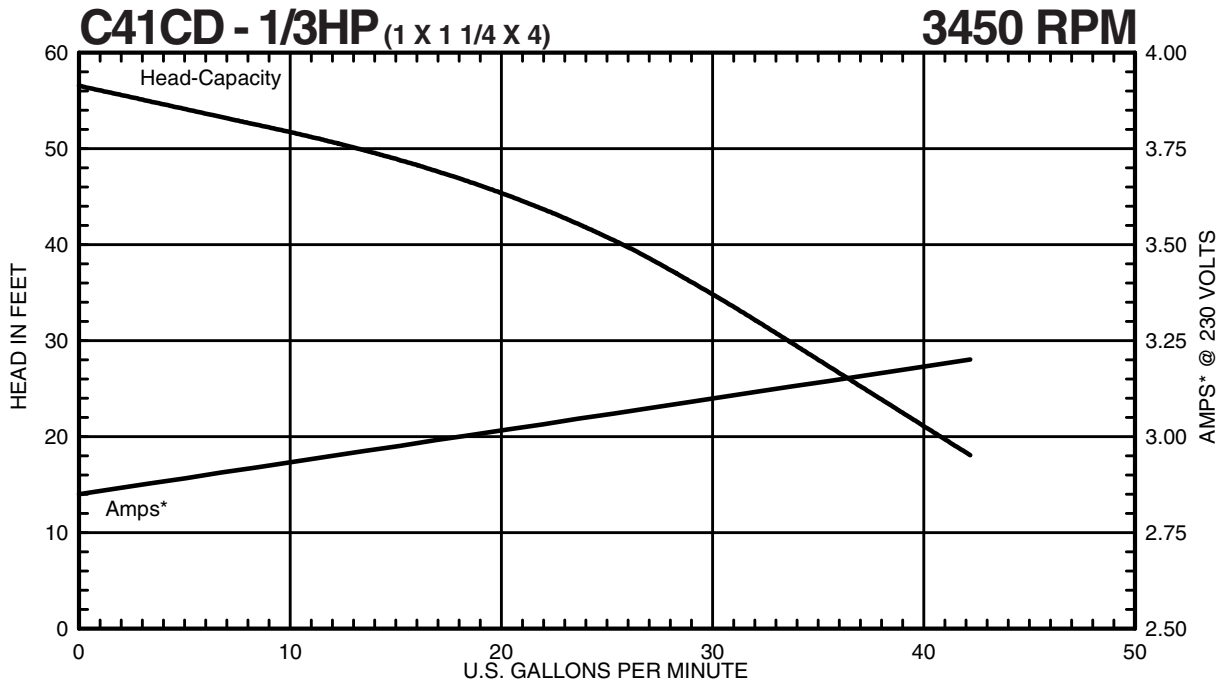

**MTH PUMPS**

401 West Main Street • Plano, IL 60545-1436  
Phone: 630-552-4115 • Fax: 630-552-3688  
Email: SALES@MTHPUMPS.COM  
<http://WWW.MTHPUMPS.COM>

\*Amp and HP data valid for 1.0 specific gravity fluids only (1 Phase)

# Performance Curves

(Single Phase)

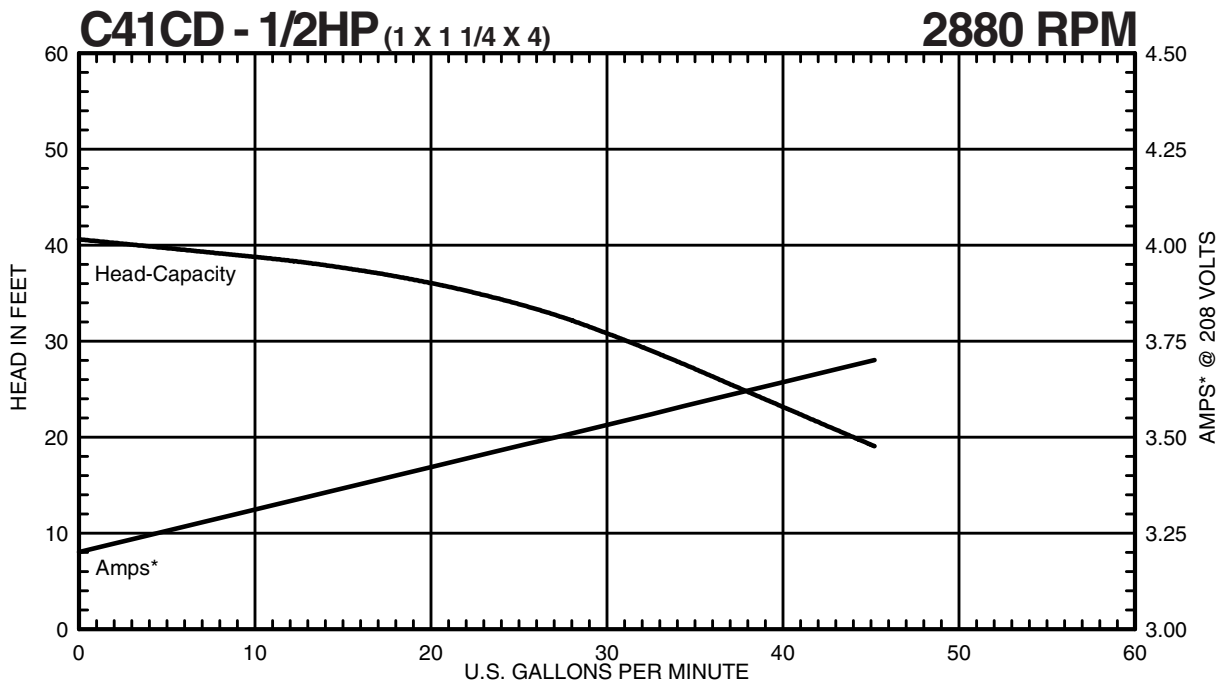
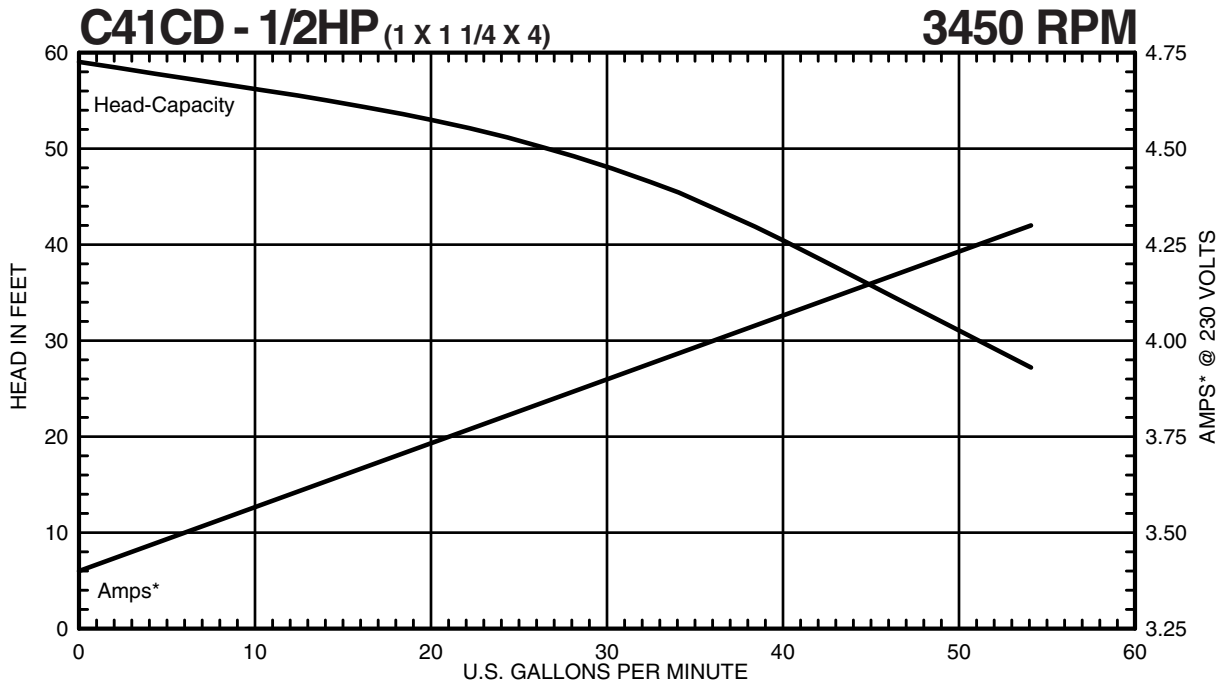

## MTH PUMPS

401 West Main Street • Plano, IL 60545-1436  
 Phone: 630-552-4115 • Fax: 630-552-3688  
 Email: SALES@MTHPUMPS.COM  
<http://WWW.MTHPUMPS.COM>

\*Amp and HP data valid for 1.0 specific gravity fluids only (1 Phase)

C41 • C51 • C61 SERIES

# Performance Curves (Single Phase)

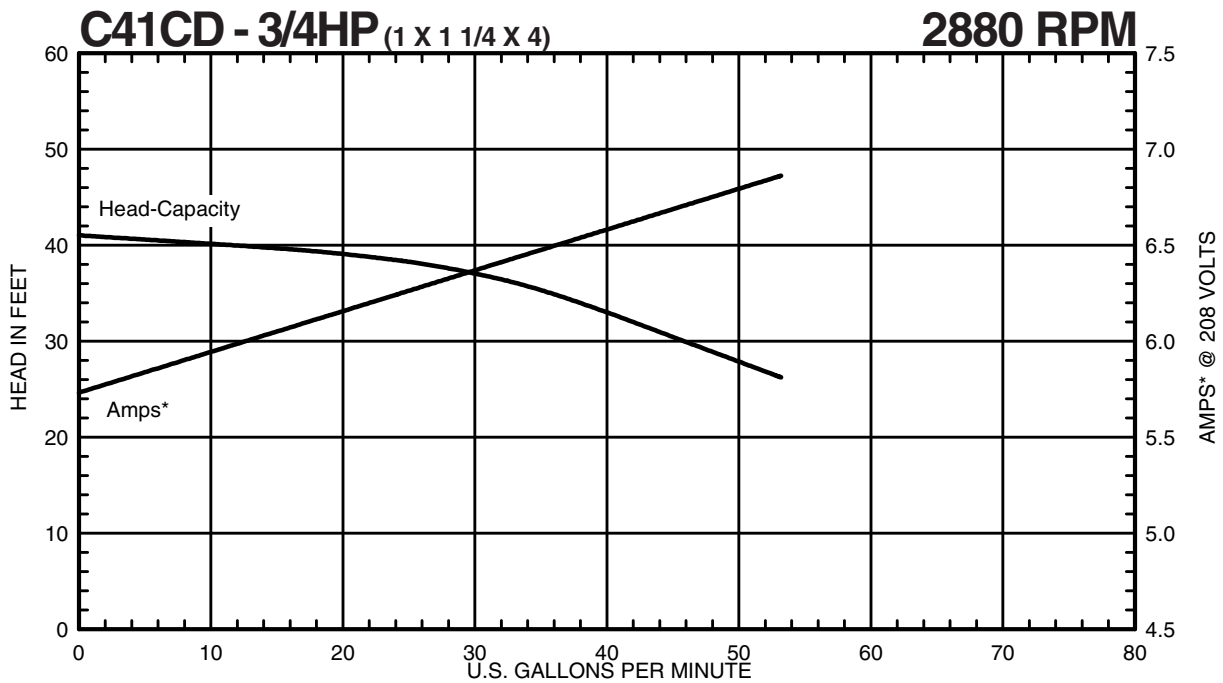
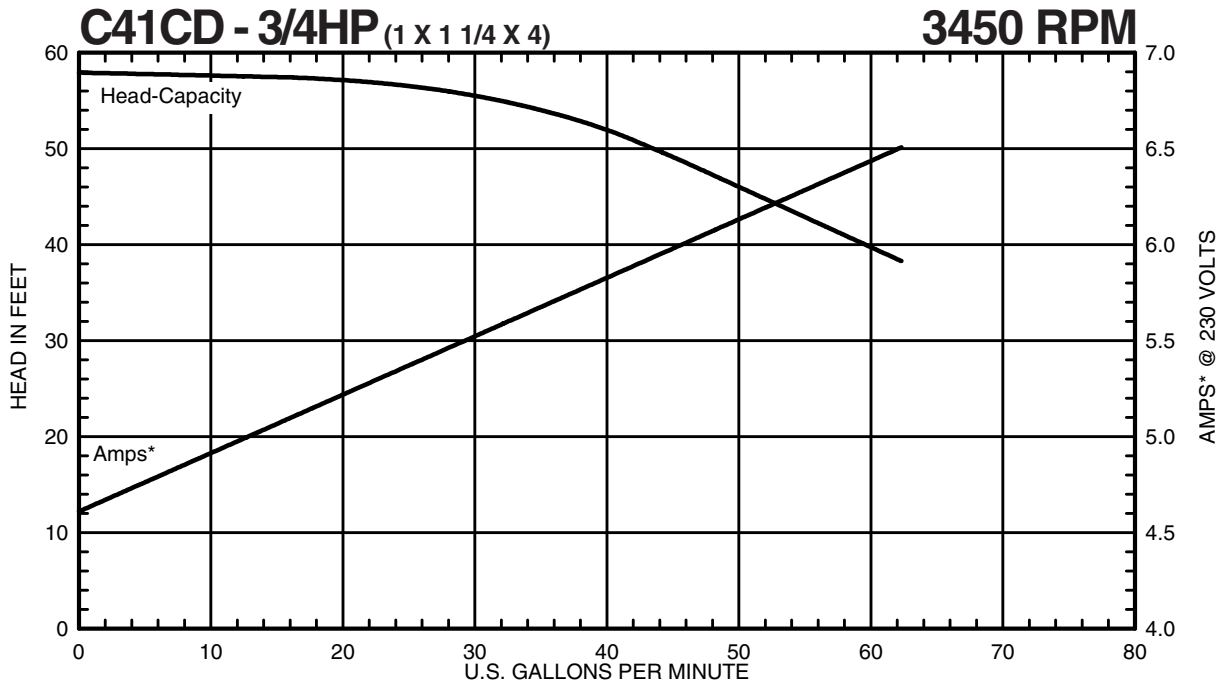

**MTH PUMPS**

401 West Main Street • Plano, IL 60545-1436  
Phone: 630-552-4115 • Fax: 630-552-3688  
Email: SALES@MTHPUMPS.COM  
<http://WWW.MTHPUMPS.COM>

\*Amp and HP data valid for 1.0 specific gravity fluids only (1 Phase)



# Performance Curves

(Single Phase)

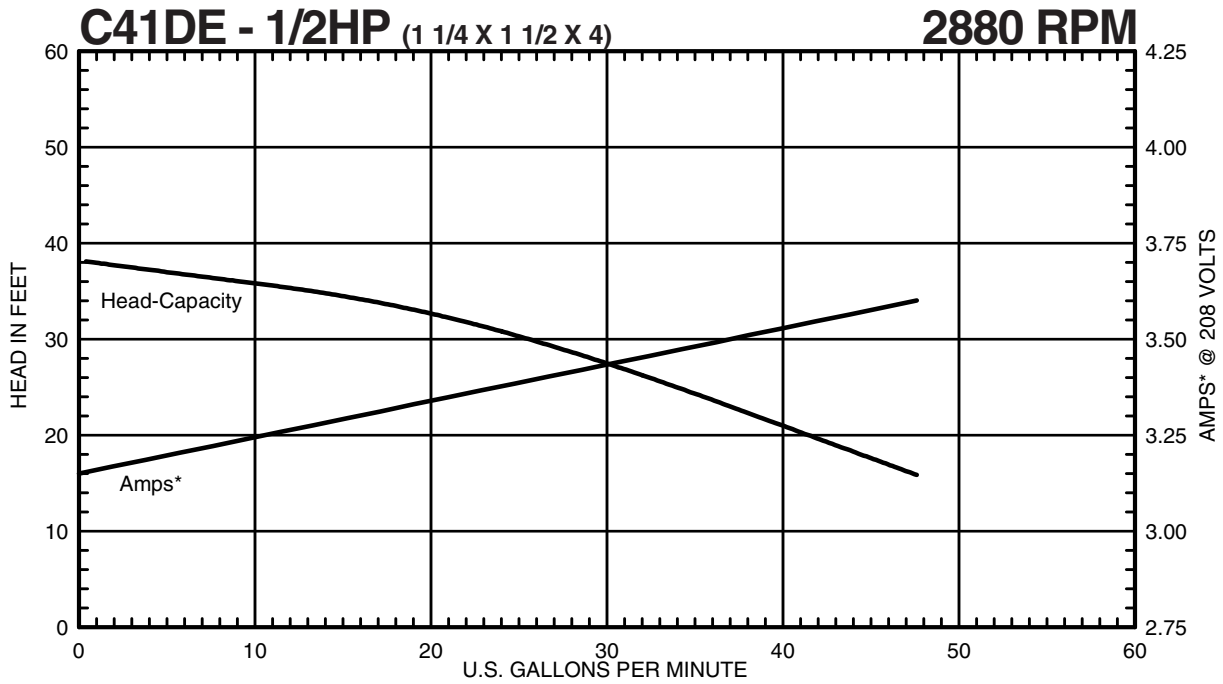
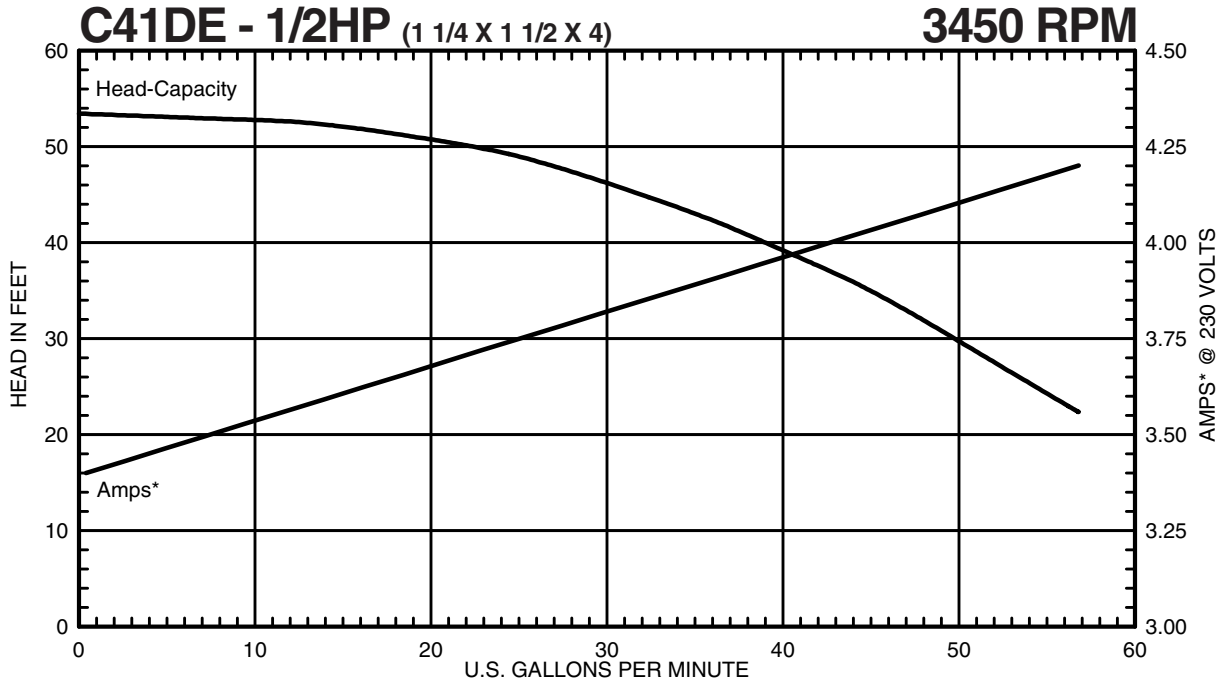

## MTH PUMPS

401 West Main Street • Plano, IL 60545-1436  
 Phone: 630-552-4115 • Fax: 630-552-3688  
 Email: SALES@MTHPUMPS.COM  
<http://WWW.MTHPUMPS.COM>

\*Amp and HP data valid for 1.0 specific gravity fluids only (1 Phase)

C41 • C51 • C61 SERIES

# Performance Curves (Single Phase)

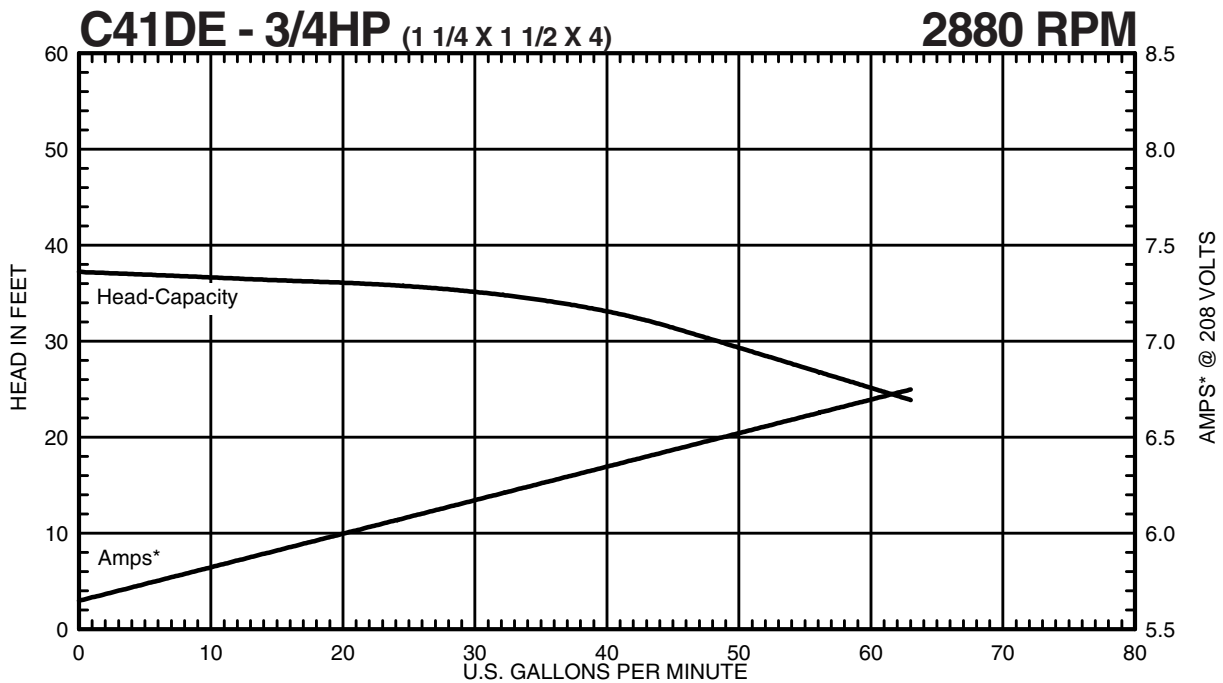
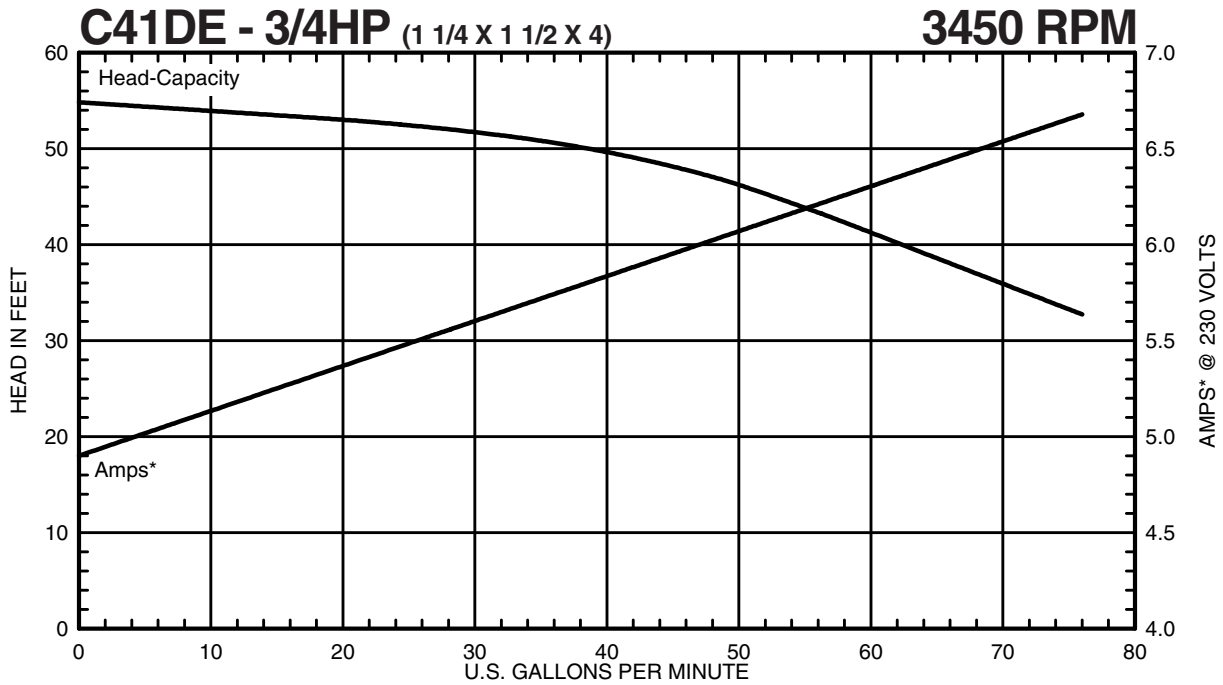

**MTH PUMPS**

401 West Main Street • Plano, IL 60545-1436  
 Phone: 630-552-4115 • Fax: 630-552-3688  
 Email: SALES@MTHPUMPS.COM  
<http://WWW.MTHPUMPS.COM>

\*Amp and HP data valid for 1.0 specific gravity fluids only (1 Phase)

# Performance Curves

(Single Phase)

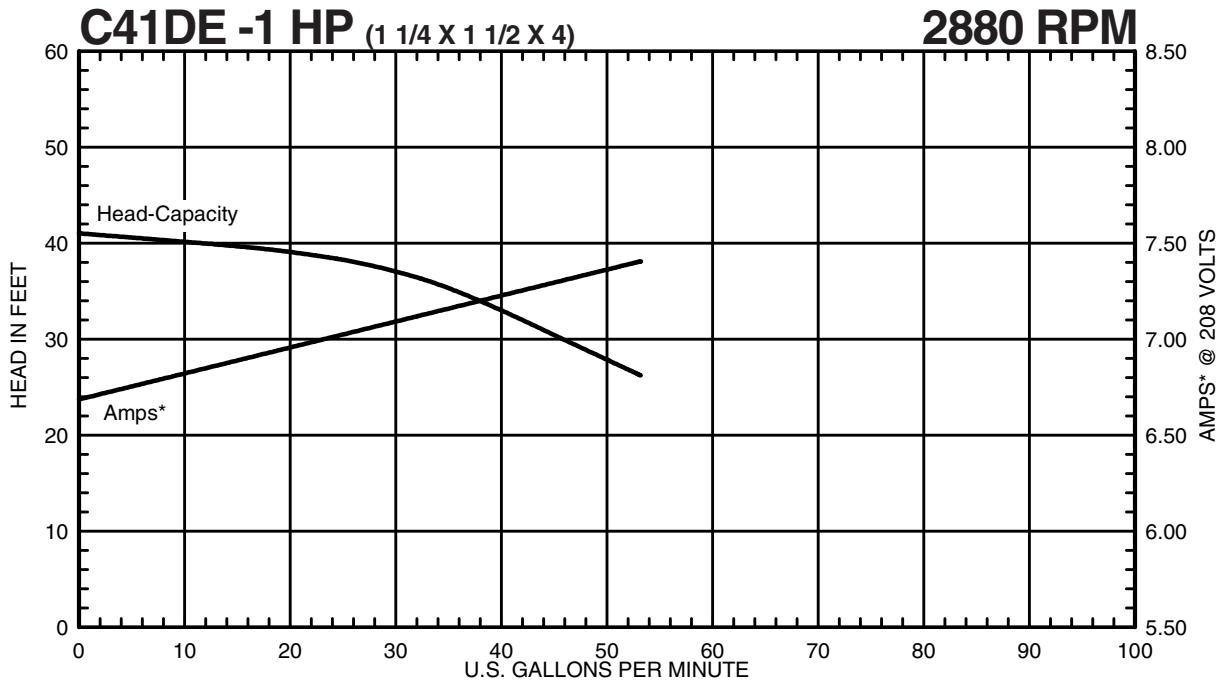
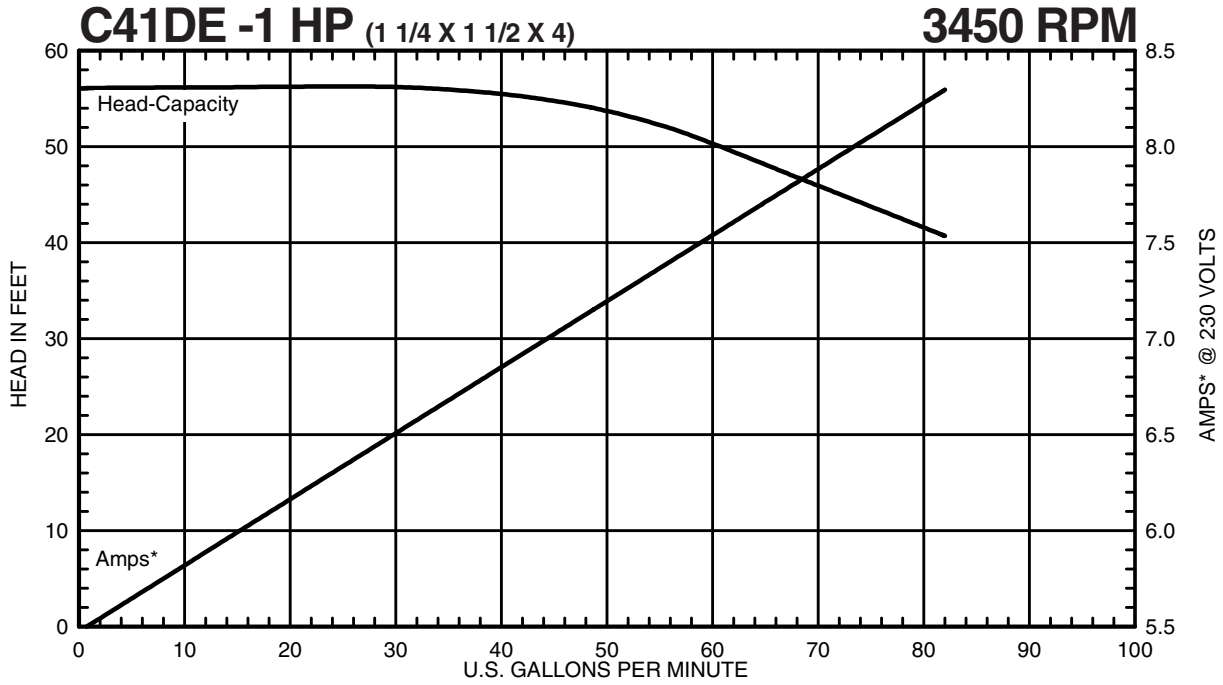

**MTH PUMPS**

401 West Main Street • Plano, IL 60545-1436  
 Phone: 630-552-4115 • Fax: 630-552-3688  
 Email: SALES@MTHPUMPS.COM  
<http://WWW.MTHPUMPS.COM>

\*Amp and HP data valid for 1.0 specific gravity fluids only (1 Phase)

C41 • C51 • C61 SERIES

# Performance Curves (Single Phase)

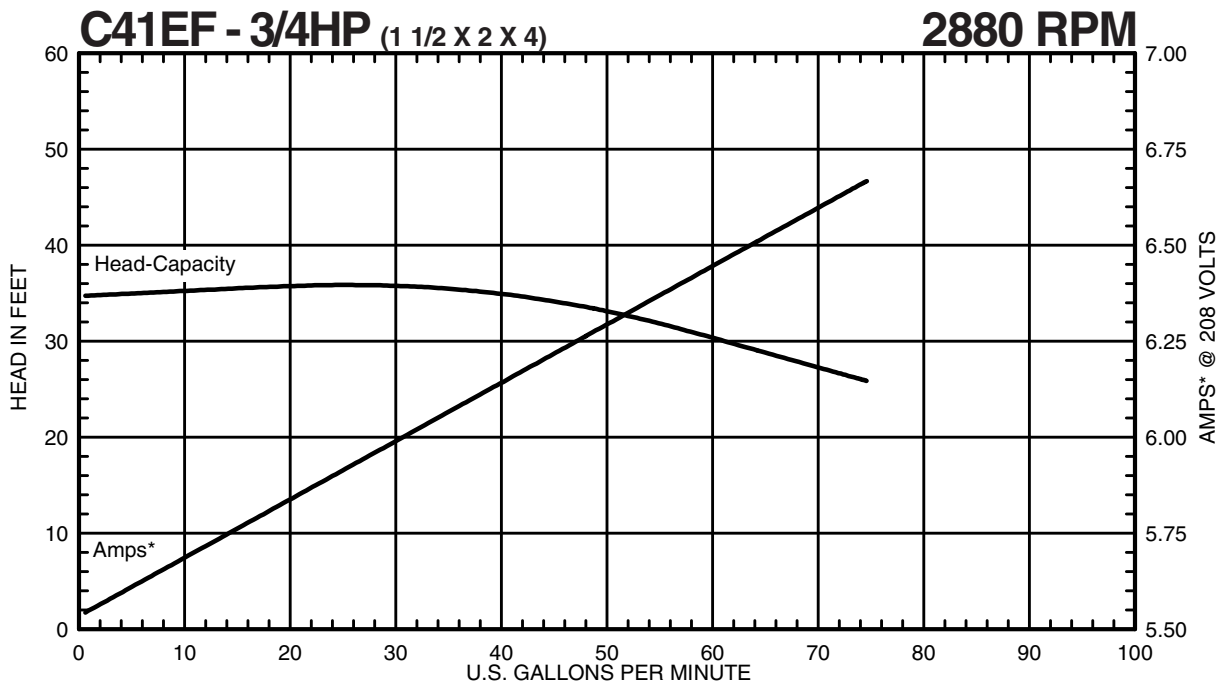
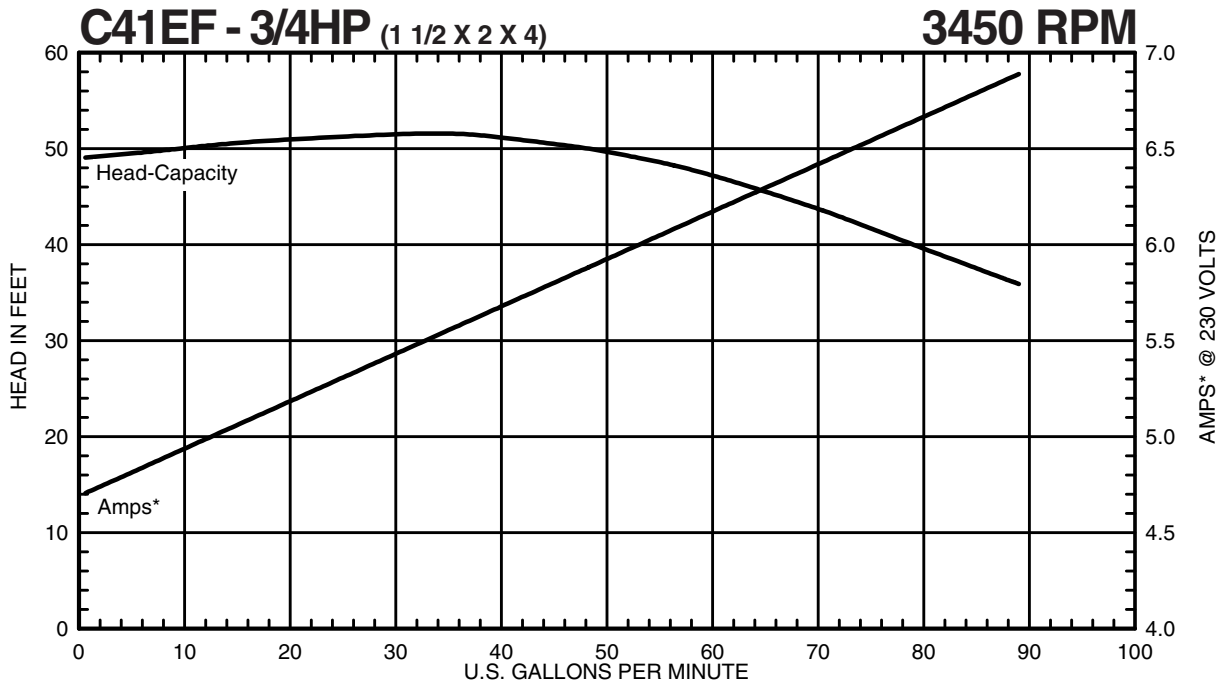

**MTH PUMPS**

401 West Main Street • Plano, IL 60545-1436  
 Phone: 630-552-4115 • Fax: 630-552-3688  
 Email: SALES@MTHPUMPS.COM  
<http://WWW.MTHPUMPS.COM>

\*Amp and HP data valid for 1.0 specific gravity fluids only (1 Phase)

# Performance Curves

(Single Phase)

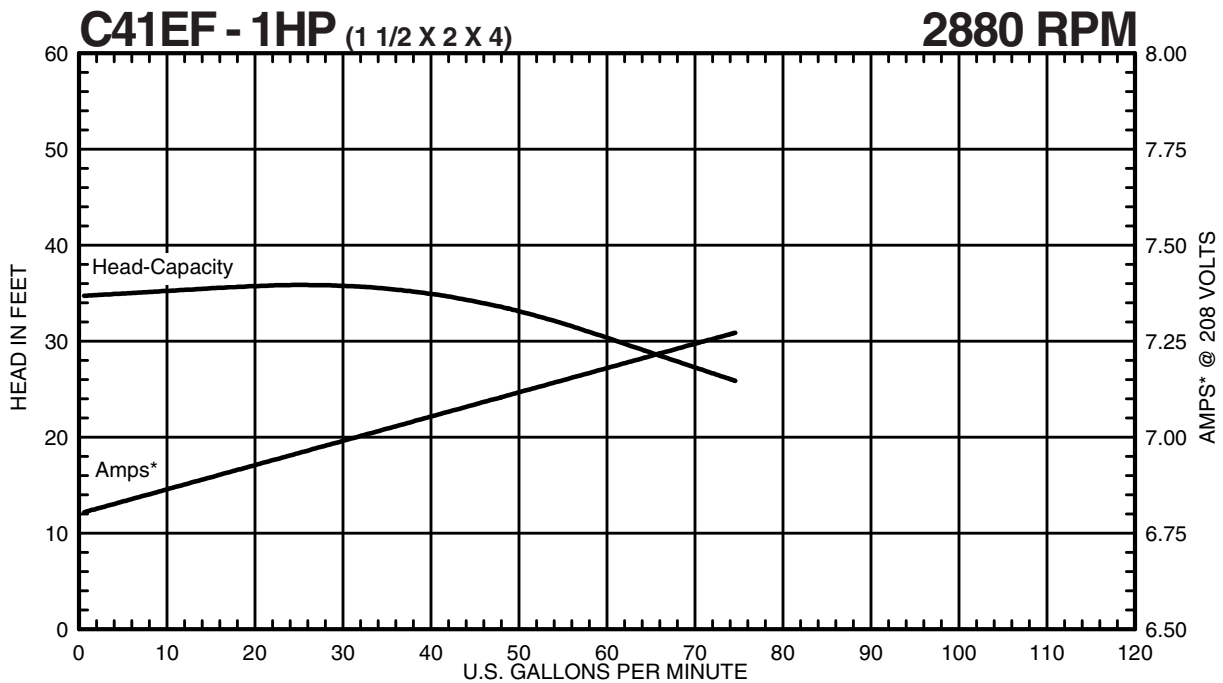
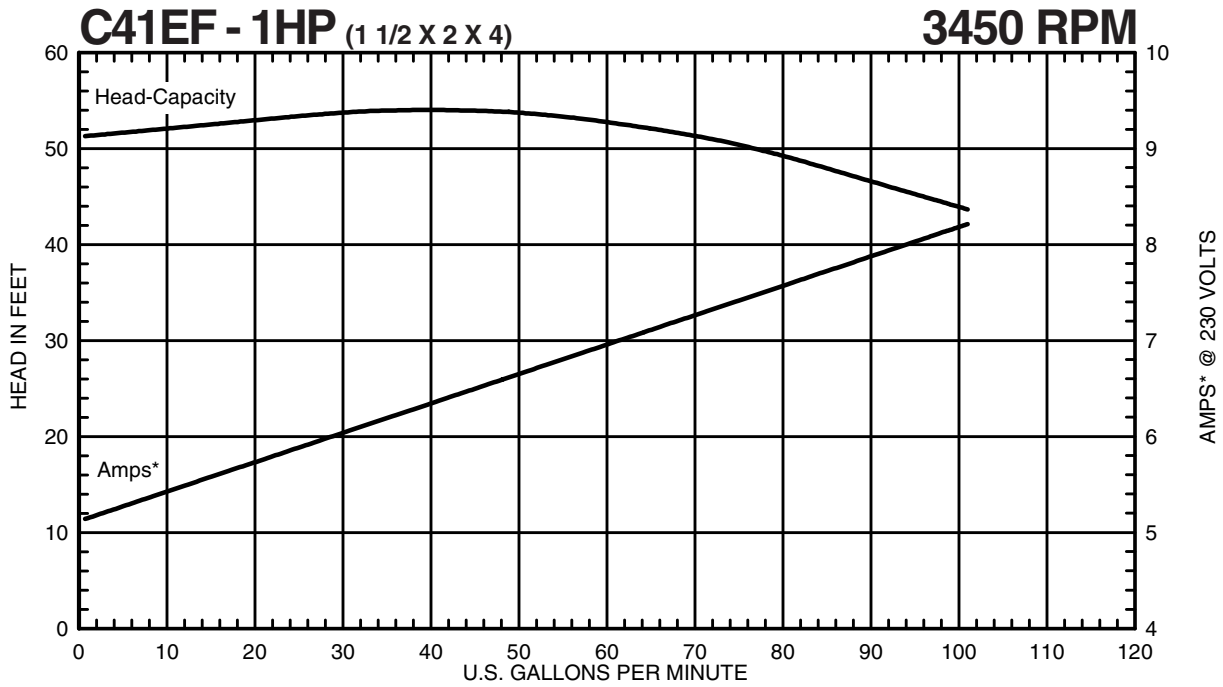

**MTH PUMPS**

401 West Main Street • Plano, IL 60545-1436  
 Phone: 630-552-4115 • Fax: 630-552-3688  
 Email: SALES@MTHPUMPS.COM  
<http://WWW.MTHPUMPS.COM>

\*Amp and HP data valid for 1.0 specific gravity fluids only (1 Phase)

C41 • C51 • C61 SERIES

# Performance Curves (Single Phase)

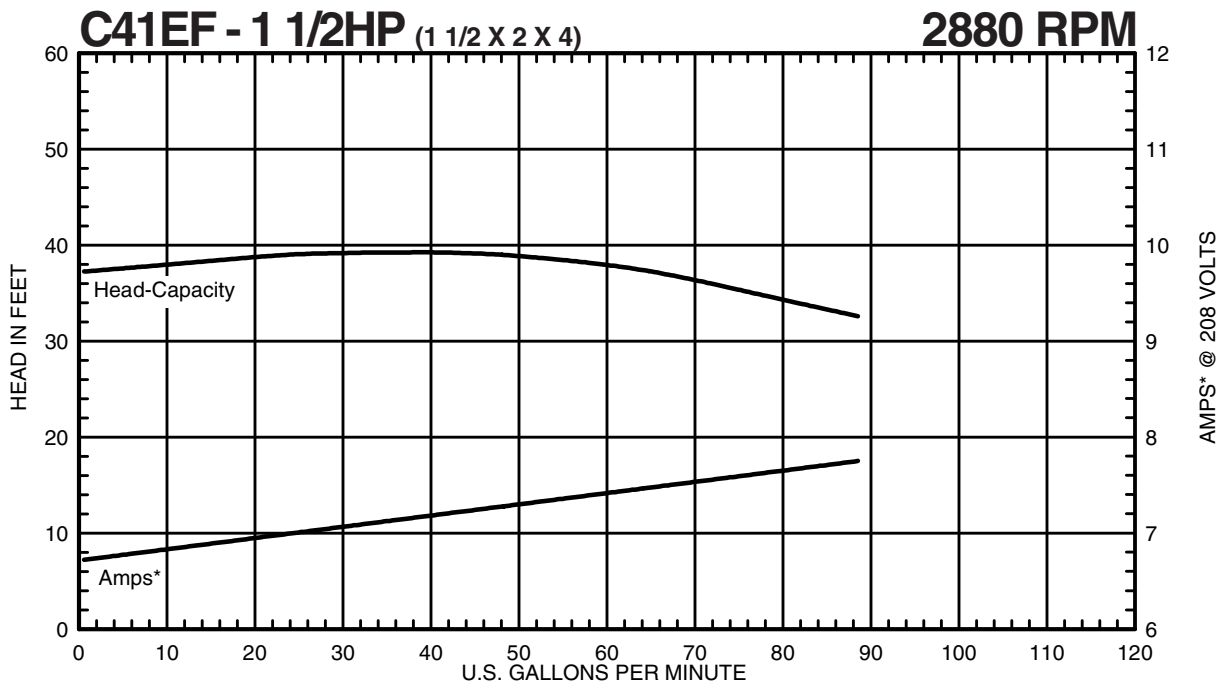
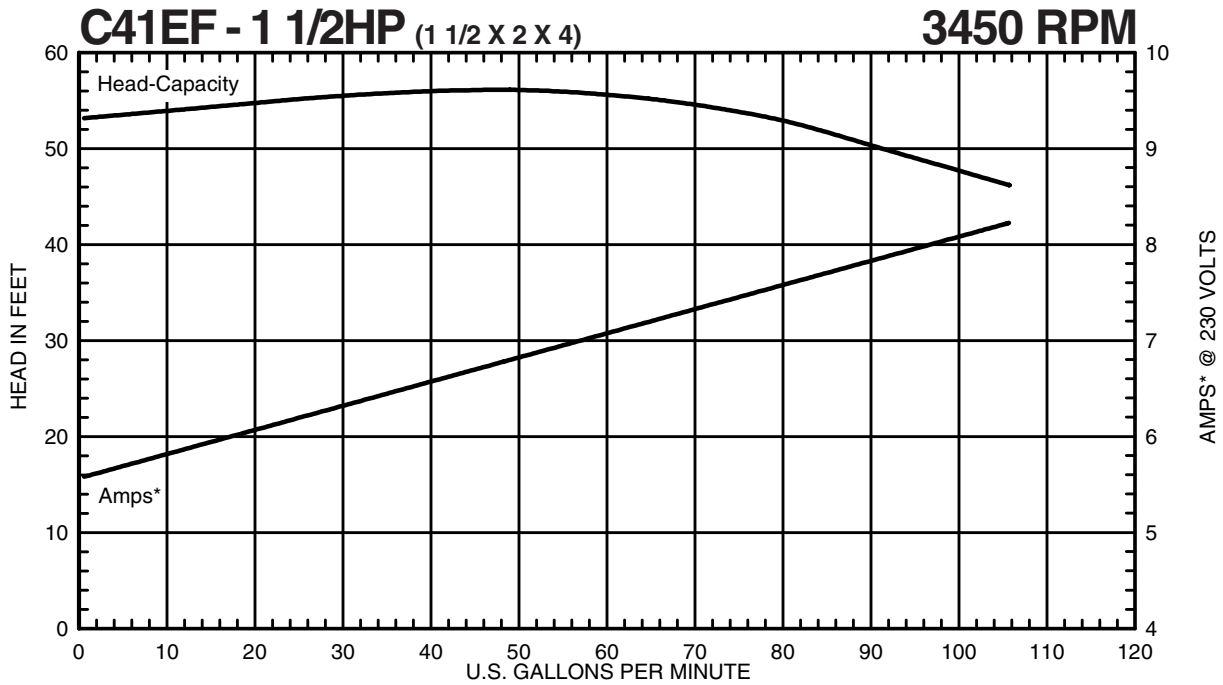

## MTH PUMPS

401 West Main Street • Plano, IL 60545-1436  
Phone: 630-552-4115 • Fax: 630-552-3688  
Email: SALES@MTHPUMPS.COM  
<http://WWW.MTHPUMPS.COM>

\*Amp and HP data valid for 1.0 specific gravity fluids only (1 Phase)

# Performance Curves

(Single Phase)

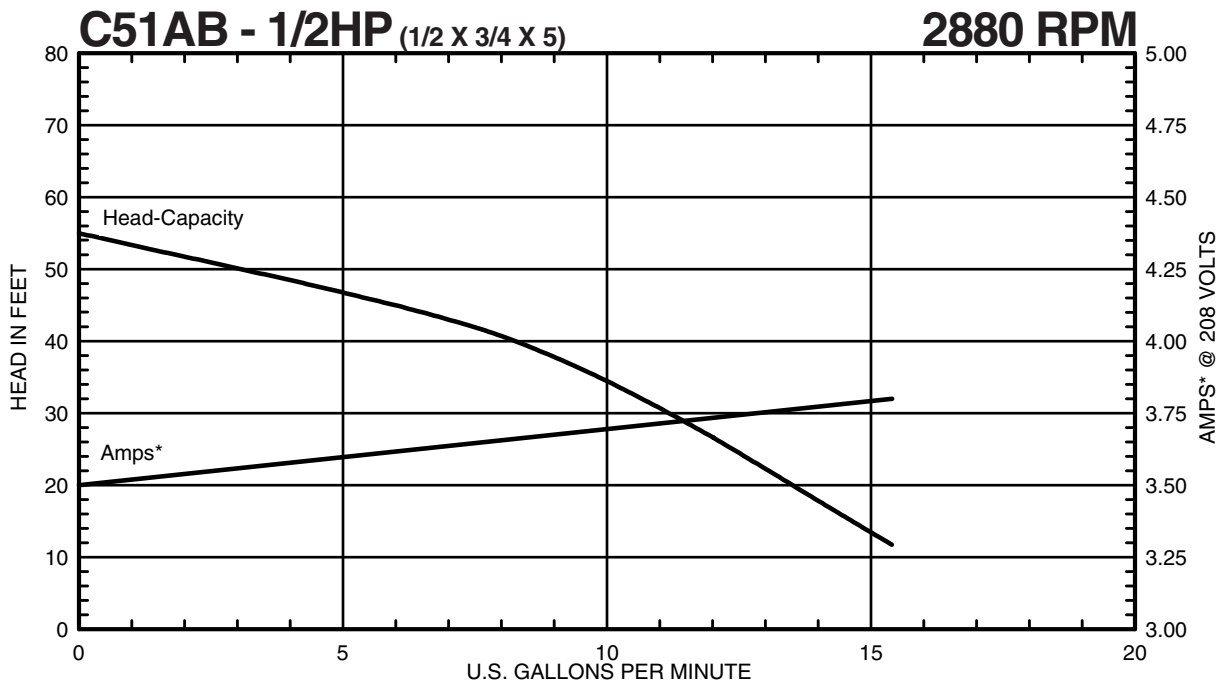
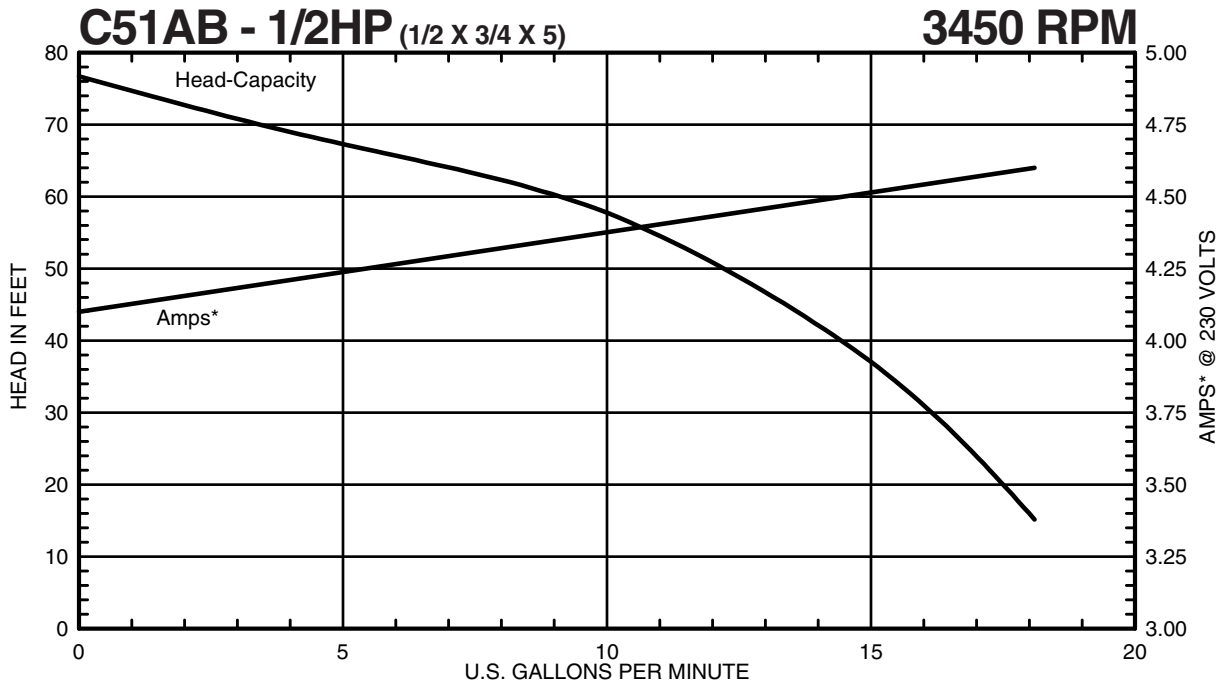

## MTH PUMPS

401 West Main Street • Plano, IL 60545-1436  
 Phone: 630-552-4115 • Fax: 630-552-3688  
 Email: SALES@MTHPUMPS.COM  
<http://WWW.MTHPUMPS.COM>

\*Amp and HP data valid for 1.0 specific gravity fluids only (1 Phase)

C41 • C51 • C61 SERIES

# Performance Curves (Single Phase)

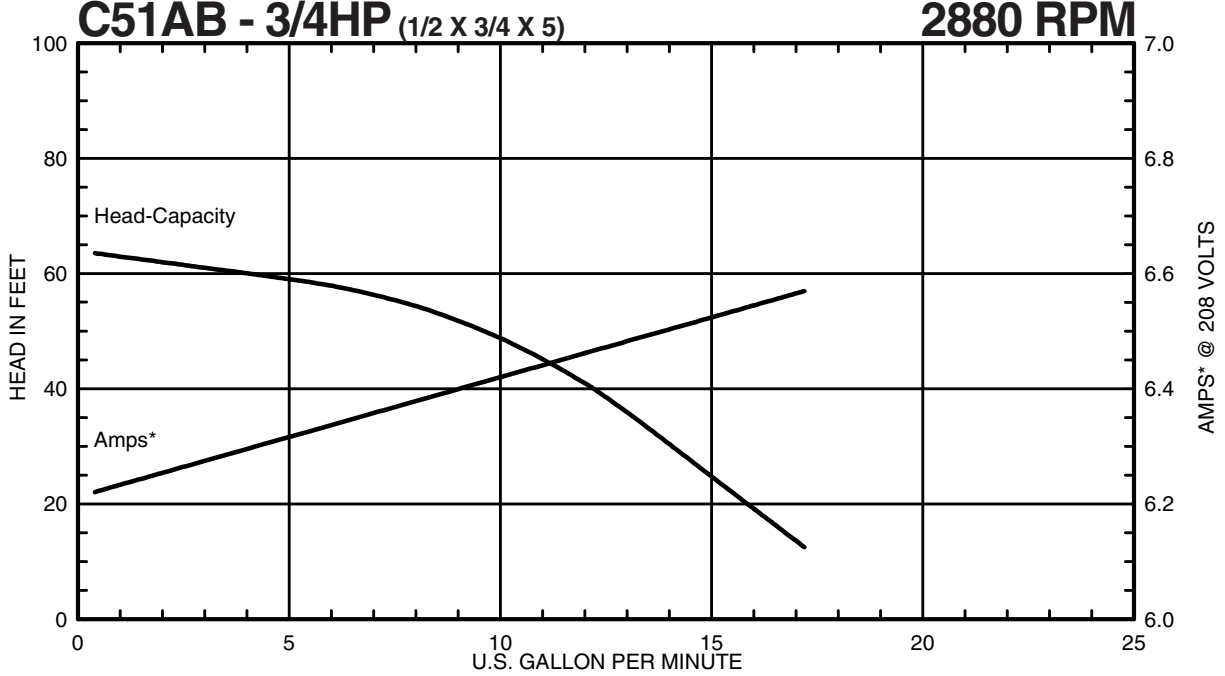
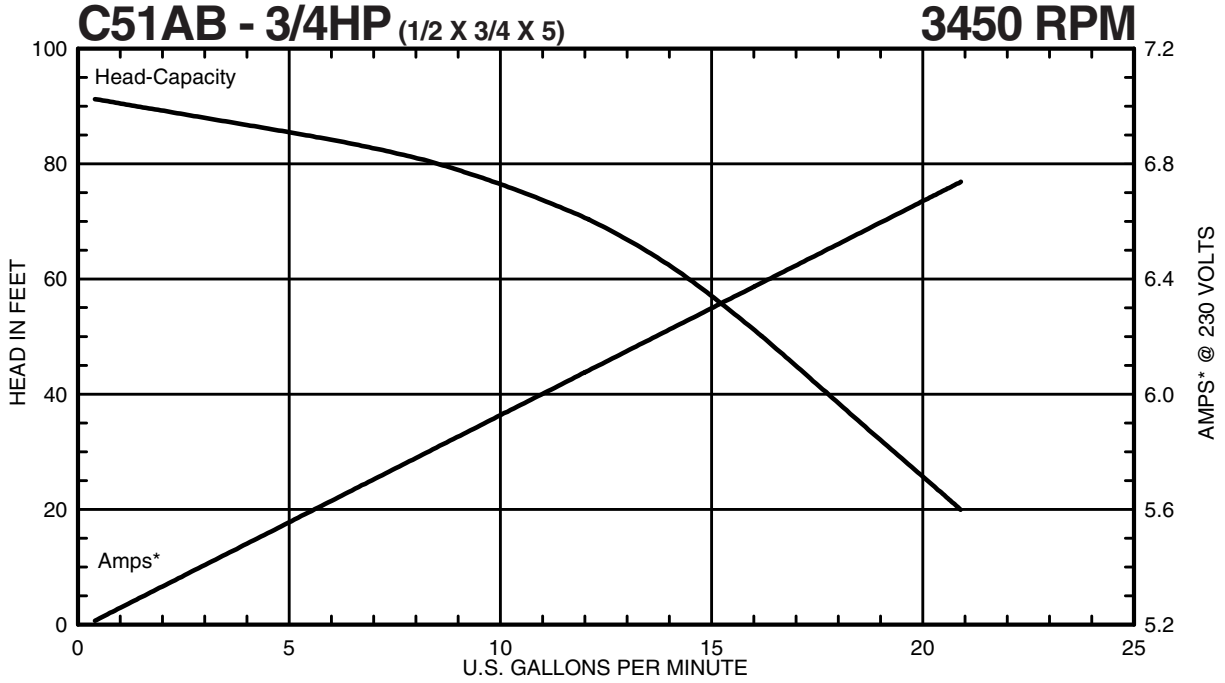

**MTH PUMPS**

401 West Main Street • Plano, IL 60545-1436  
 Phone: 630-552-4115 • Fax: 630-552-3688  
 Email: SALES@MTHPUMPS.COM  
<http://WWW.MTHPUMPS.COM>

\*Amp and HP data valid for 1.0 specific gravity fluids only (1 Phase)



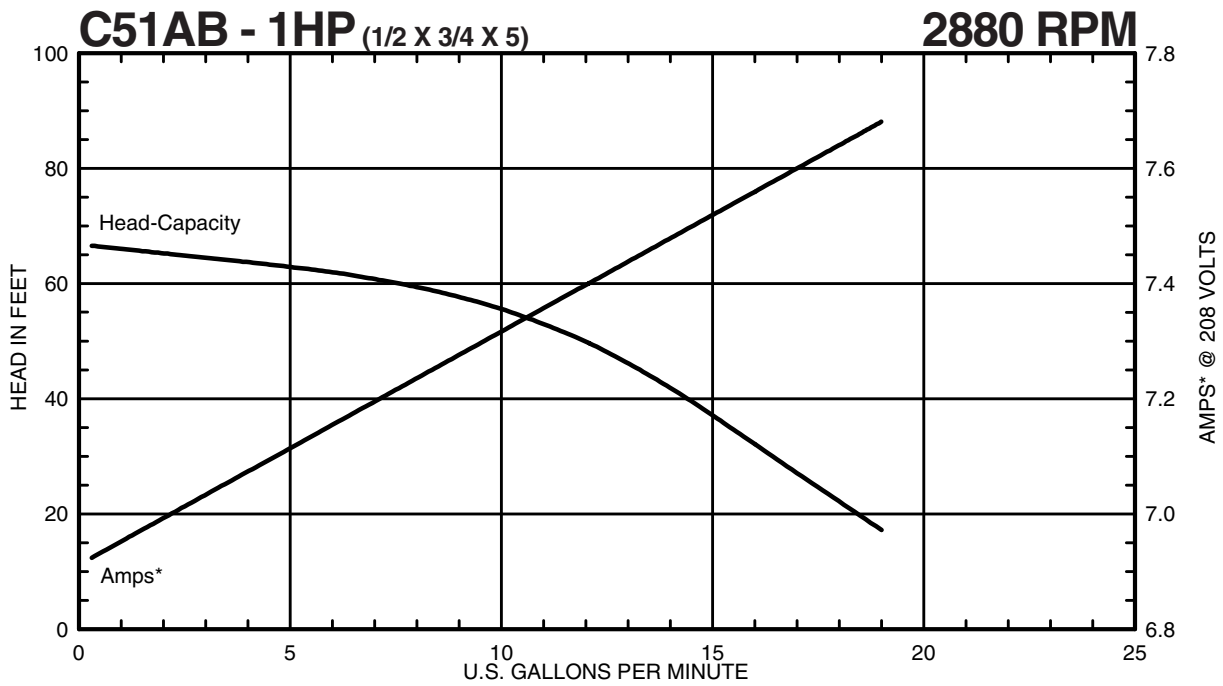
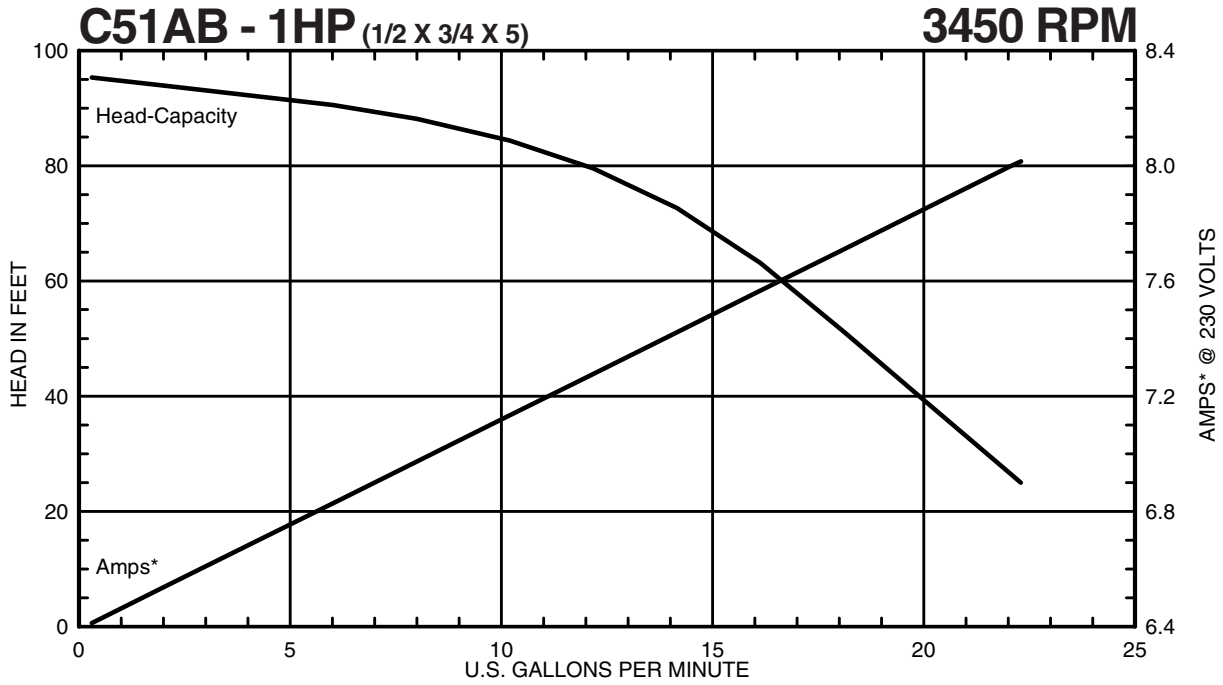

**MTH PUMPS**

401 West Main Street • Plano, IL 60545-1436  
 Phone: 630-552-4115 • Fax: 630-552-3688  
 Email: SALES@MTHPUMPS.COM  
<http://WWW.MTHPUMPS.COM>

\*Amp and HP data valid for 1.0 specific gravity fluids only (1 Phase)

C41 • C51 • C61 SERIES

# Performance Curves (Single Phase)

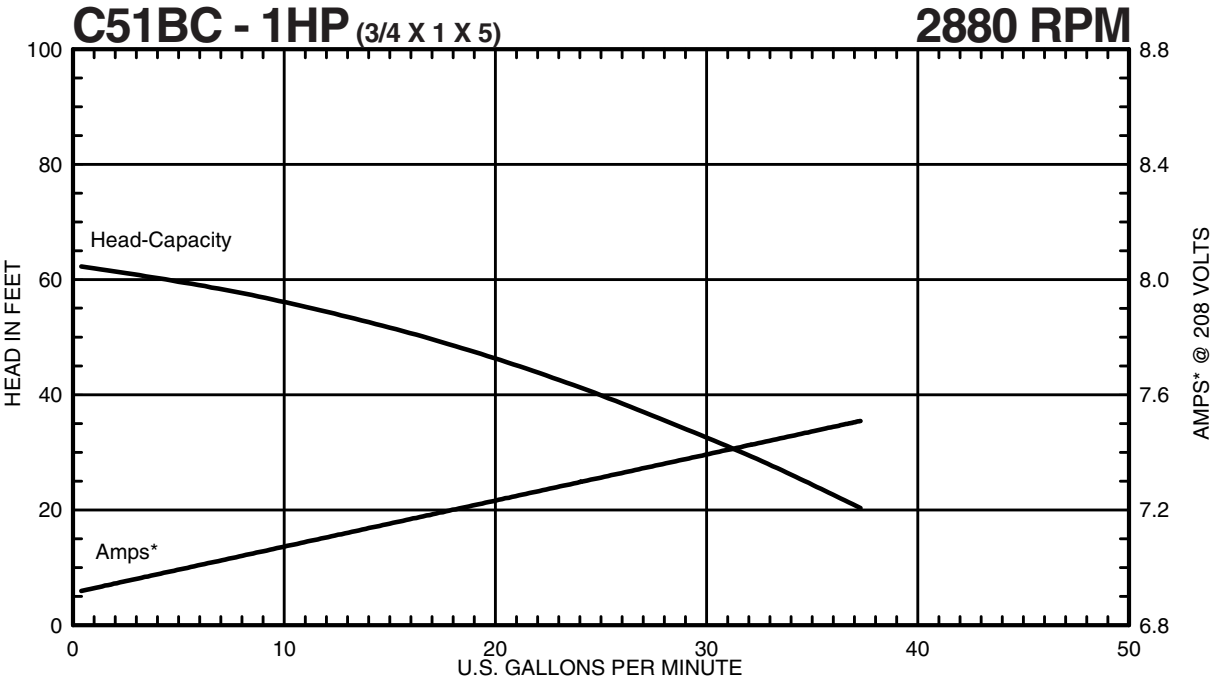
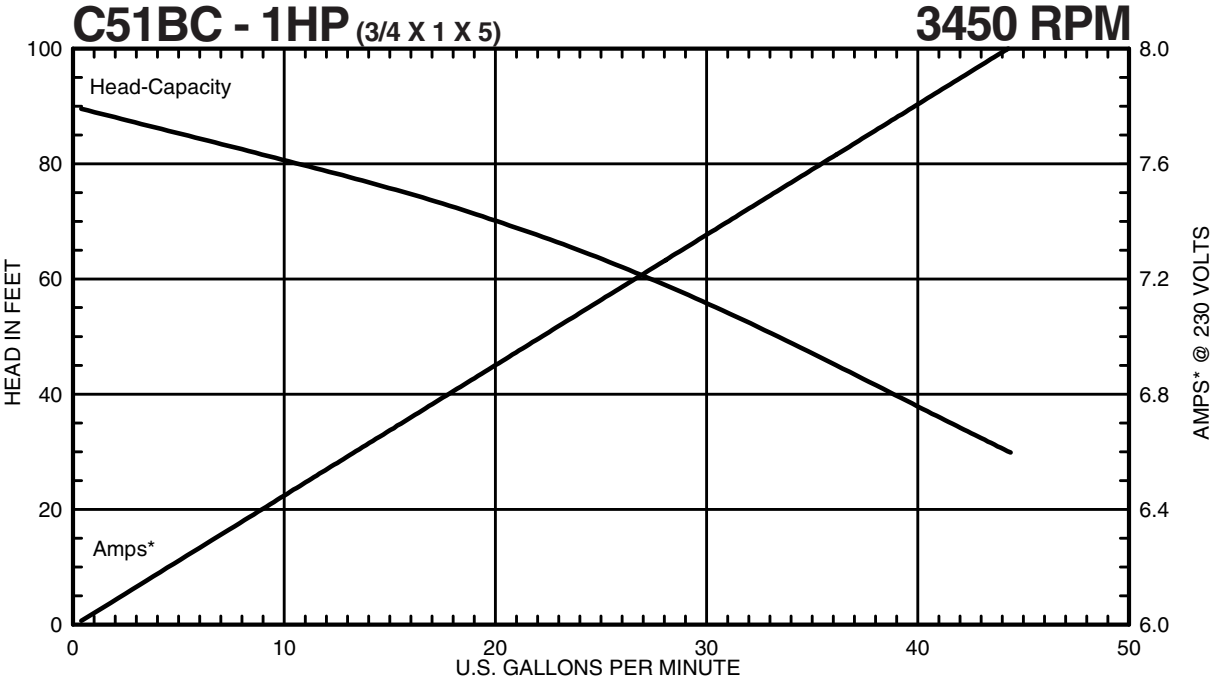

**MTH PUMPS**

401 West Main Street • Plano, IL 60545-1436  
 Phone: 630-552-4115 • Fax: 630-552-3688  
 Email: SALES@MTHPUMPS.COM  
<http://WWW.MTHPUMPS.COM>

\*Amp and HP data valid for 1.0 specific gravity fluids only (1 Phase)

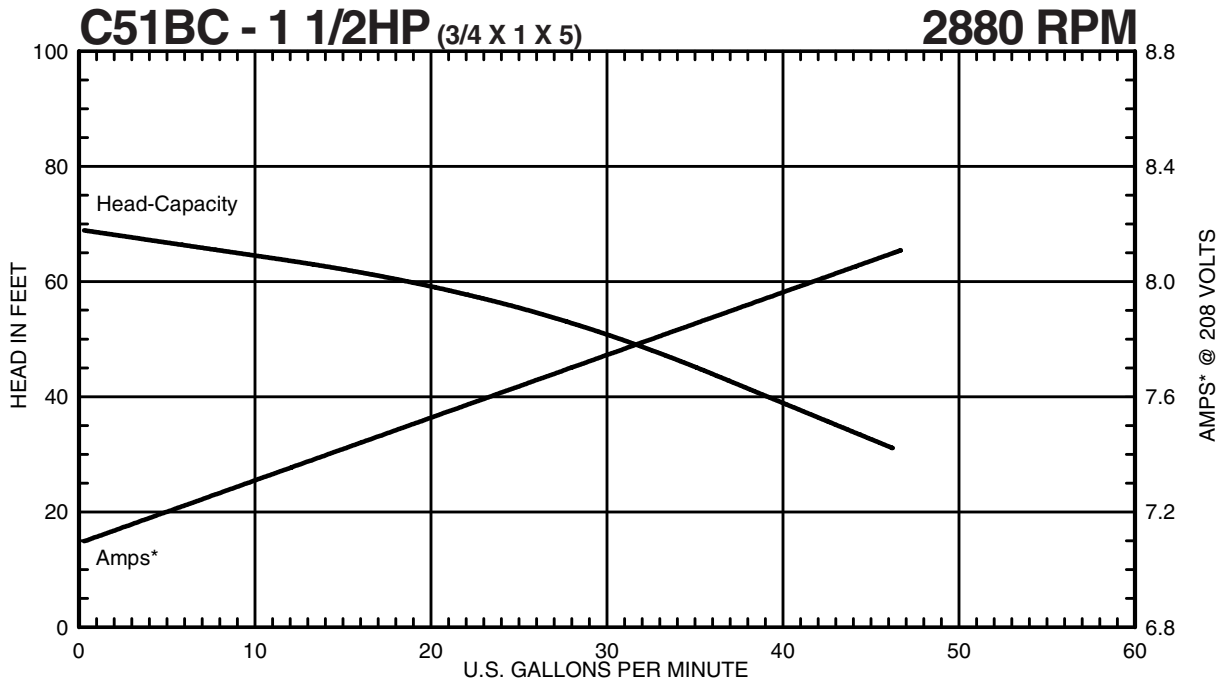
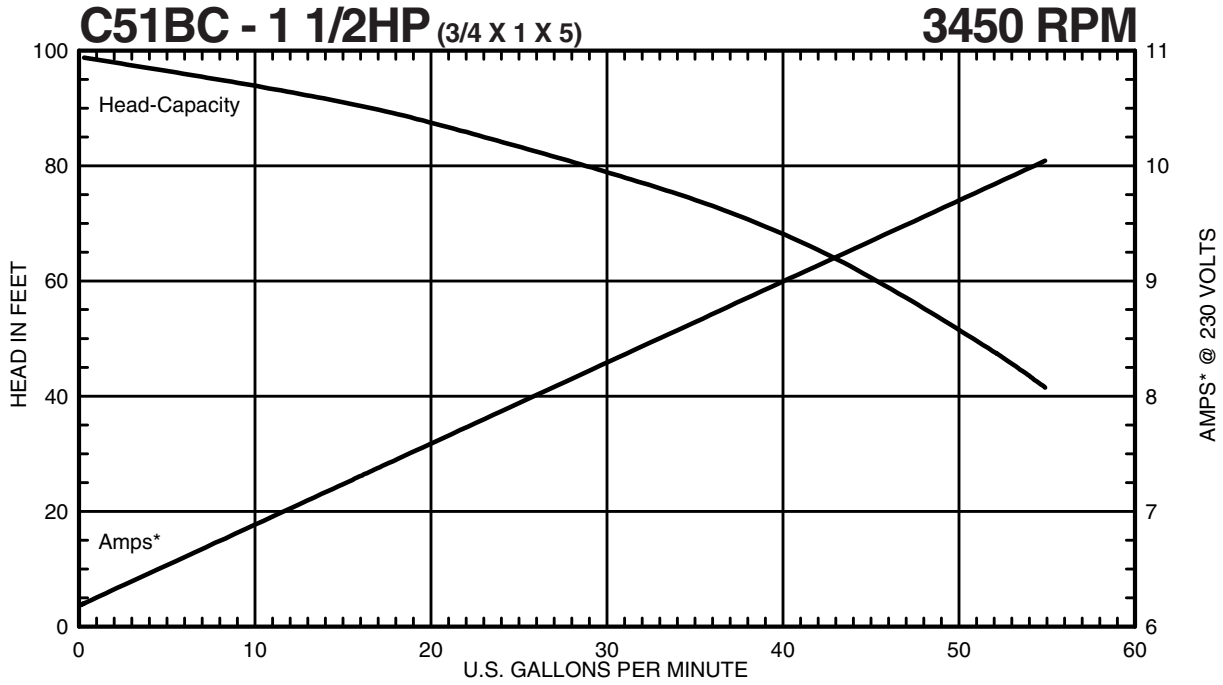

**MTH PUMPS**

401 West Main Street • Plano, IL 60545-1436  
 Phone: 630-552-4115 • Fax: 630-552-3688  
 Email: SALES@MTHPUMPS.COM  
<http://WWW.MTHPUMPS.COM>

\*Amp and HP data valid for 1.0 specific gravity fluids only (1 Phase)

C41 • C51 • C61 SERIES

# Performance Curves (Single Phase)

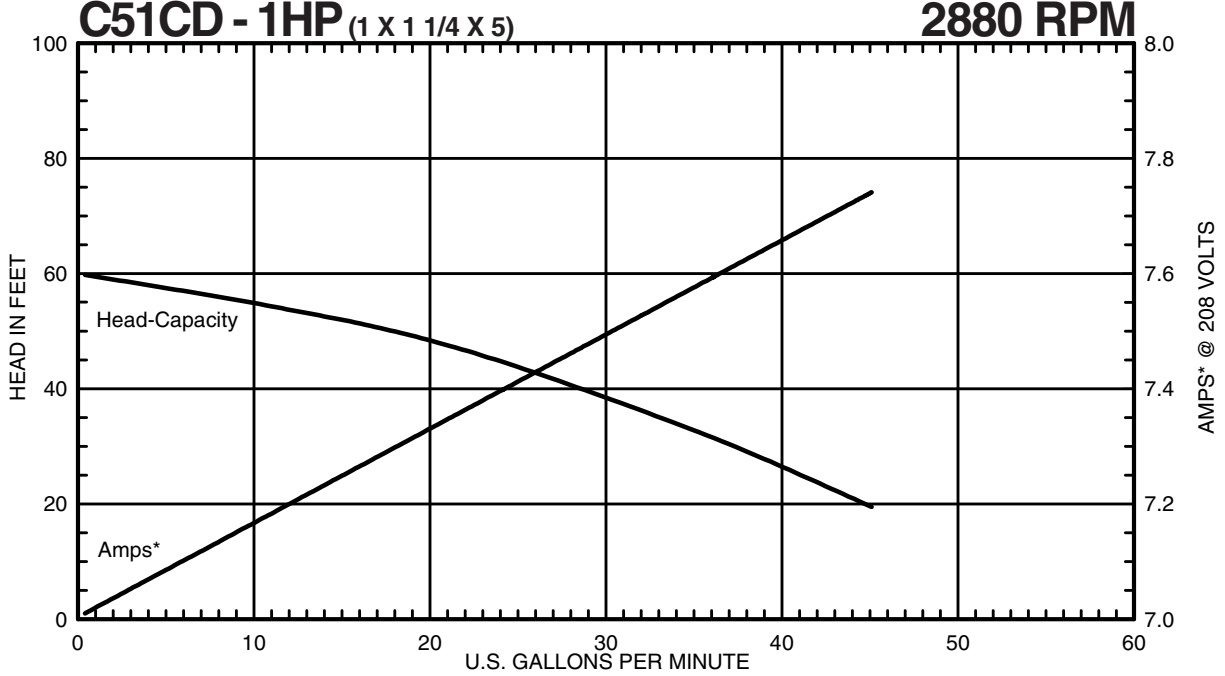
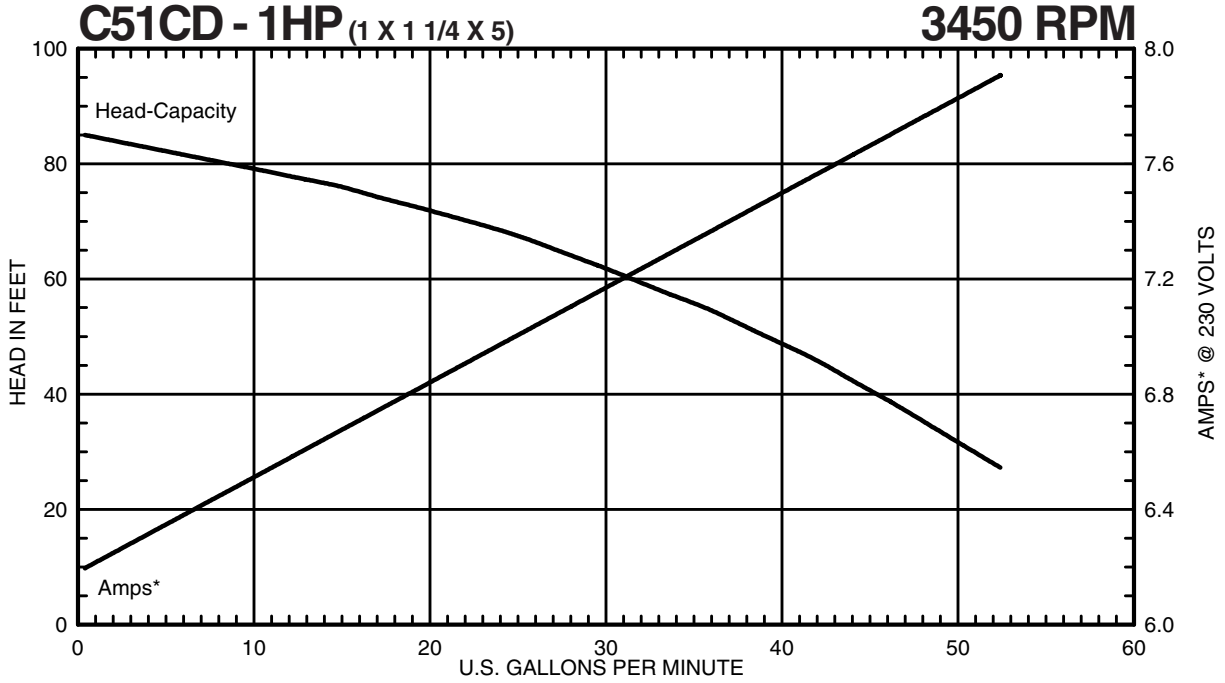

**MTH PUMPS**

401 West Main Street • Plano, IL 60545-1436  
 Phone: 630-552-4115 • Fax: 630-552-3688  
 Email: SALES@MTHPUMPS.COM  
 http://WWW.MTHPUMPS.COM

\*Amp and HP data valid for 1.0 specific gravity fluids only (1 Phase)

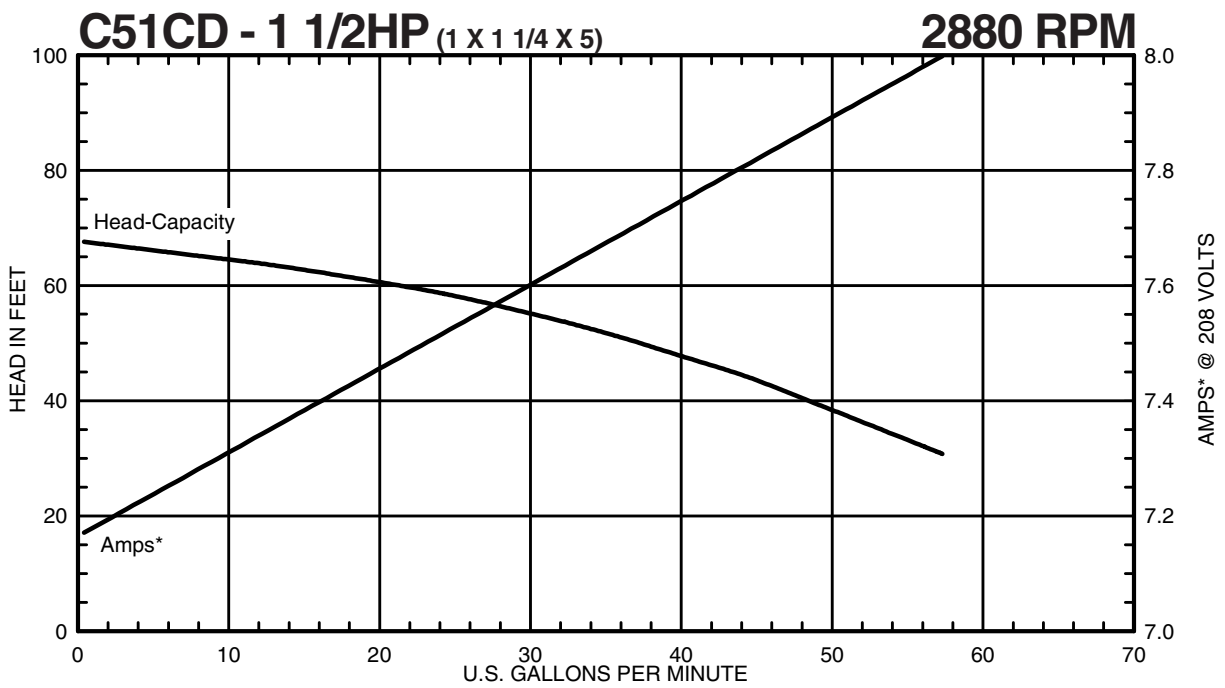
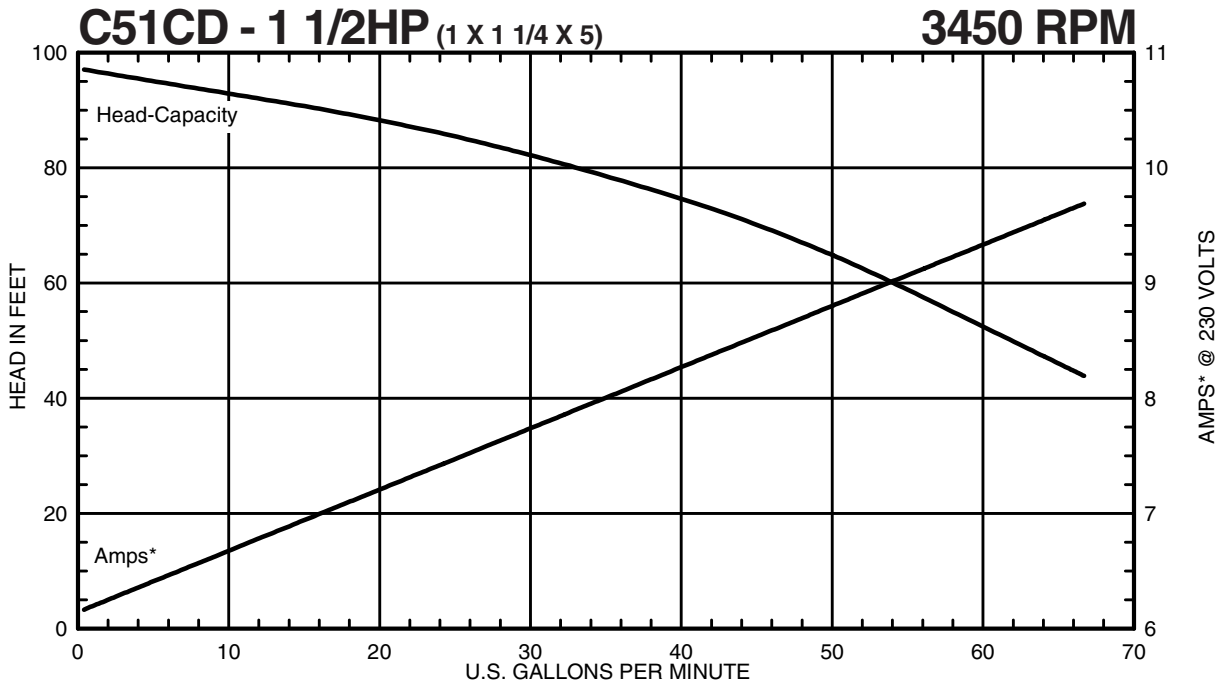

**MTH PUMPS**

401 West Main Street • Plano, IL 60545-1436  
 Phone: 630-552-4115 • Fax: 630-552-3688  
 Email: SALES@MTHPUMPS.COM  
<http://WWW.MTHPUMPS.COM>

\*Amp and HP data valid for 1.0 specific gravity fluids only (1 Phase)

C41 • C51 • C61 SERIES

# Performance Curves (Single Phase)

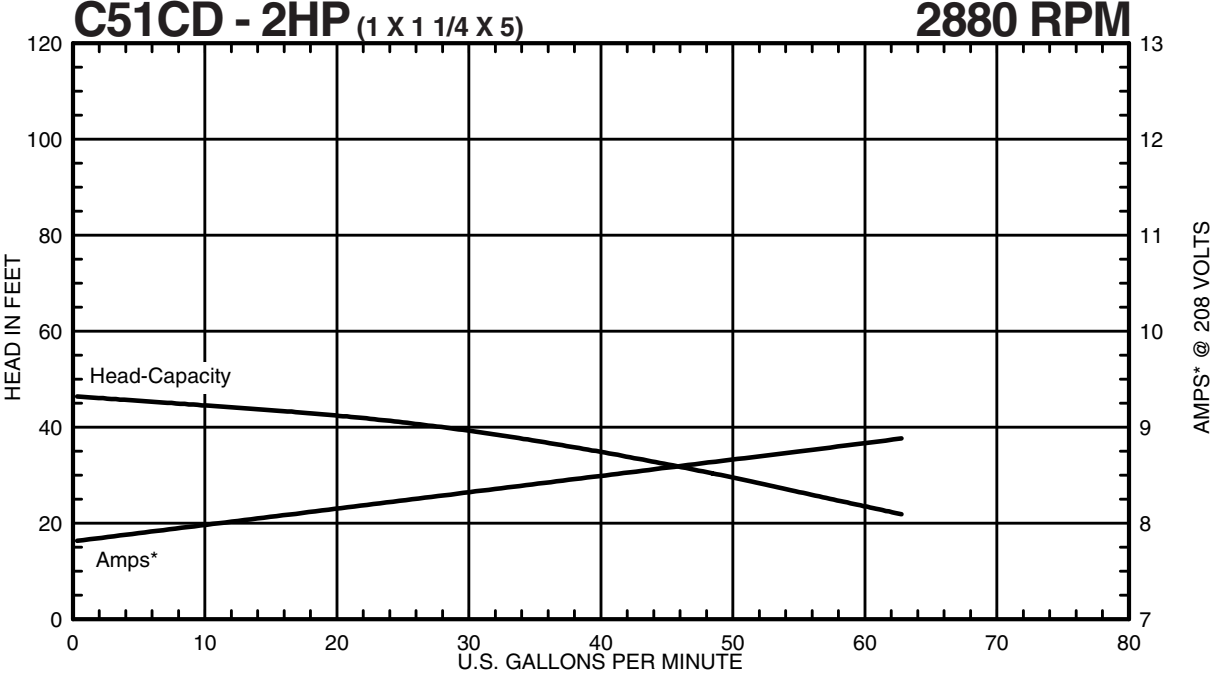
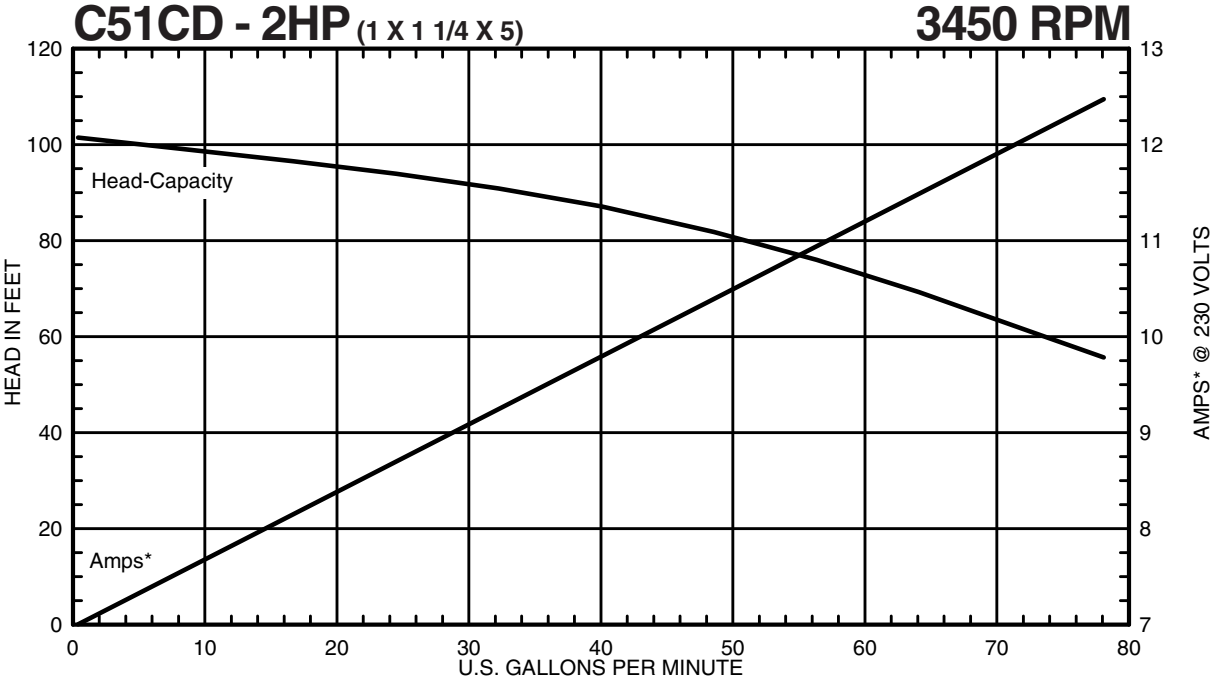

**MTH PUMPS**

401 West Main Street • Plano, IL 60545-1436  
 Phone: 630-552-4115 • Fax: 630-552-3688  
 Email: SALES@MTHPUMPS.COM  
<http://WWW.MTHPUMPS.COM>

\*Amp and HP data valid for 1.0 specific gravity fluids only (1 Phase)

# Performance Curves

(Single Phase)

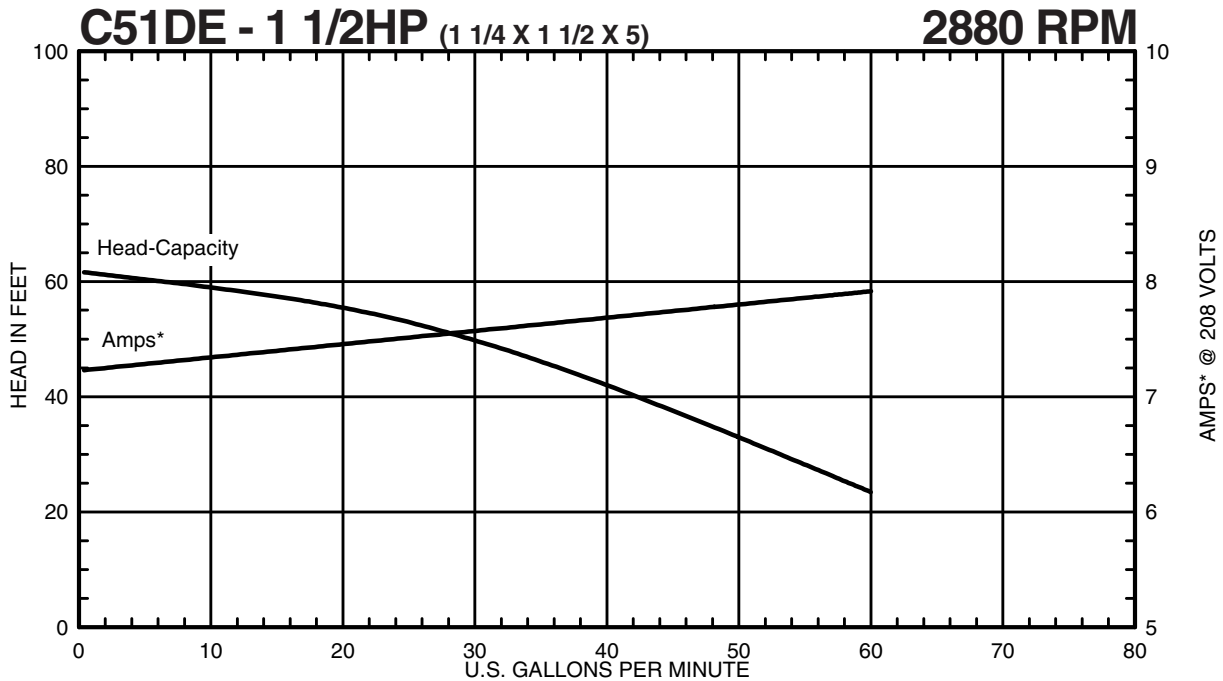
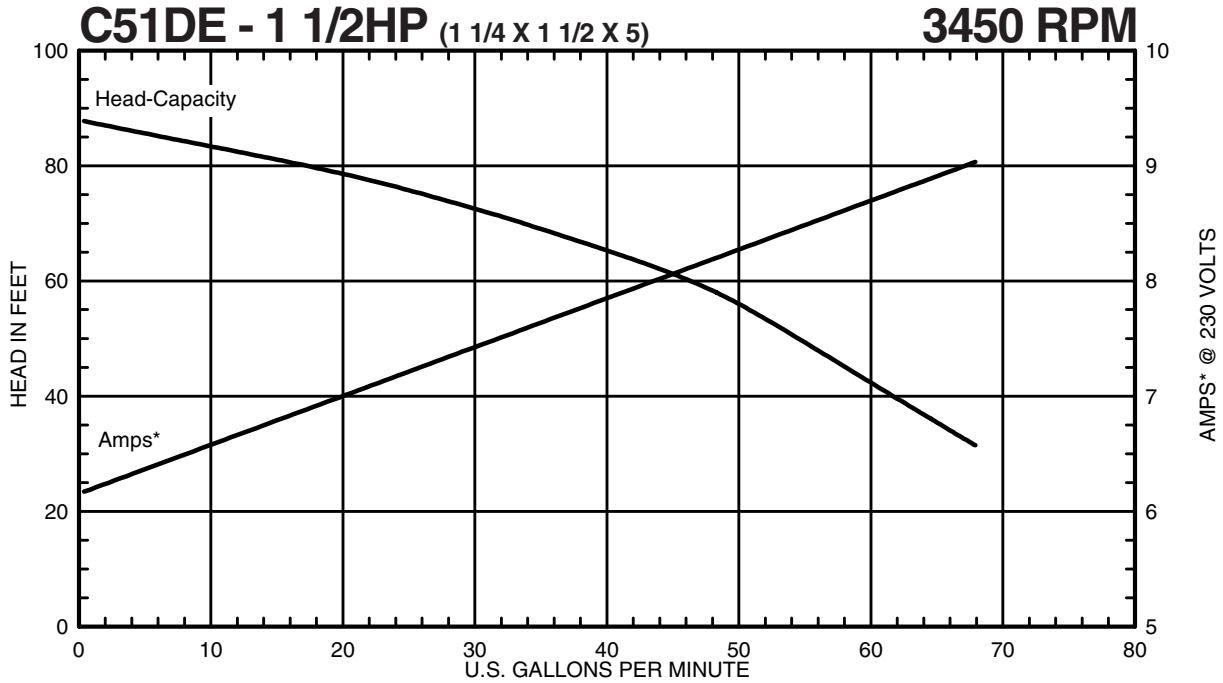

**MTH PUMPS**

401 West Main Street • Plano, IL 60545-1436  
 Phone: 630-552-4115 • Fax: 630-552-3688  
 Email: SALES@MTHPUMPS.COM  
<http://WWW.MTHPUMPS.COM>

\*Amp and HP data valid for 1.0 specific gravity fluids only (1 Phase)

C41 • C51 • C61 SERIES

# Performance Curves (Single Phase)

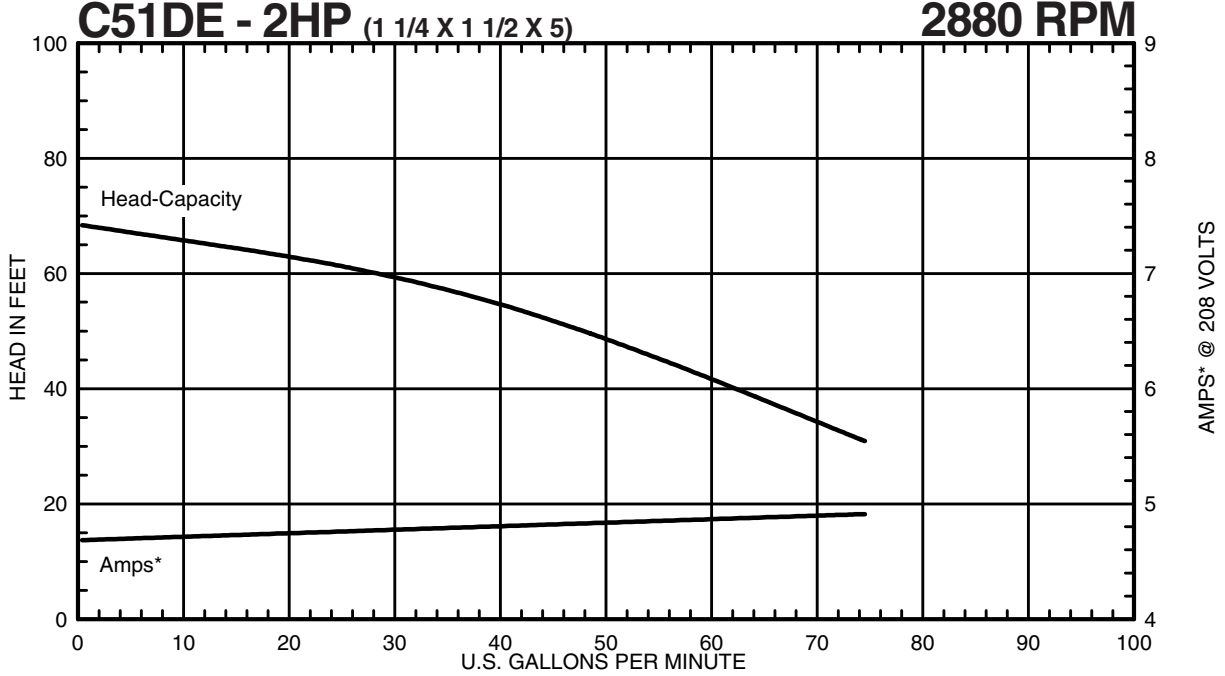
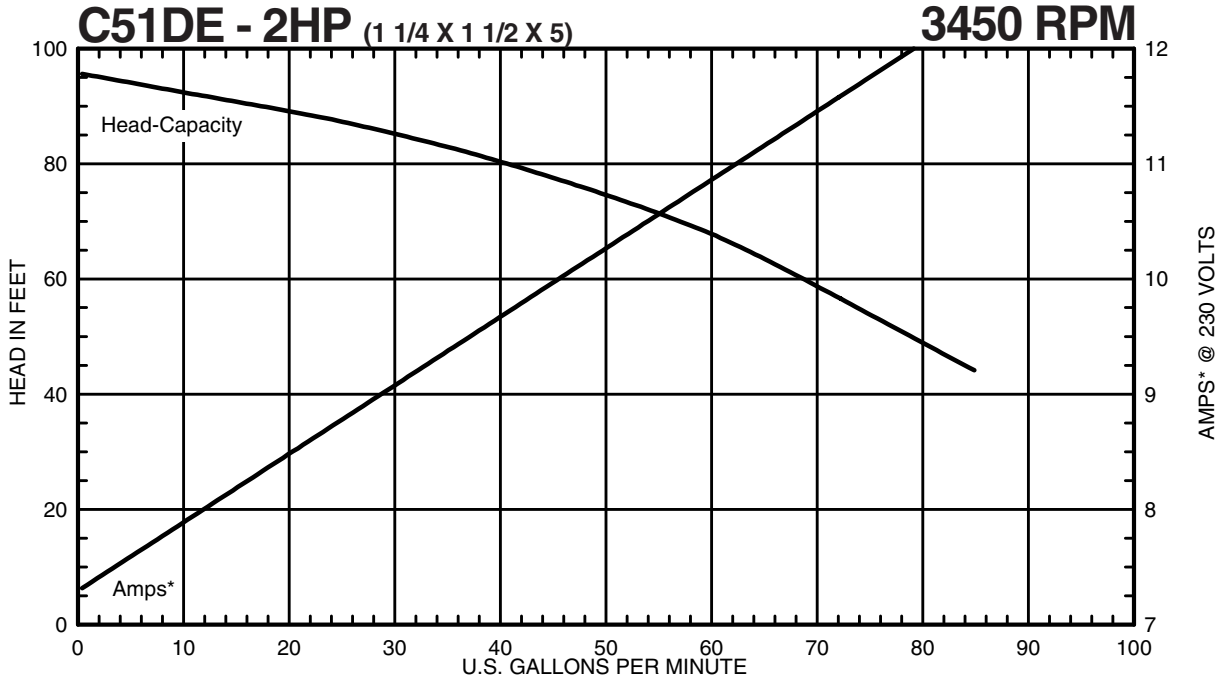

**MTH PUMPS**

401 West Main Street • Plano, IL 60545-1436  
 Phone: 630-552-4115 • Fax: 630-552-3688  
 Email: SALES@MTHPUMPS.COM  
<http://WWW.MTHPUMPS.COM>

\*Amp and HP data valid for 1.0 specific gravity fluids only (1 Phase)



# Performance Curves

(Single Phase)

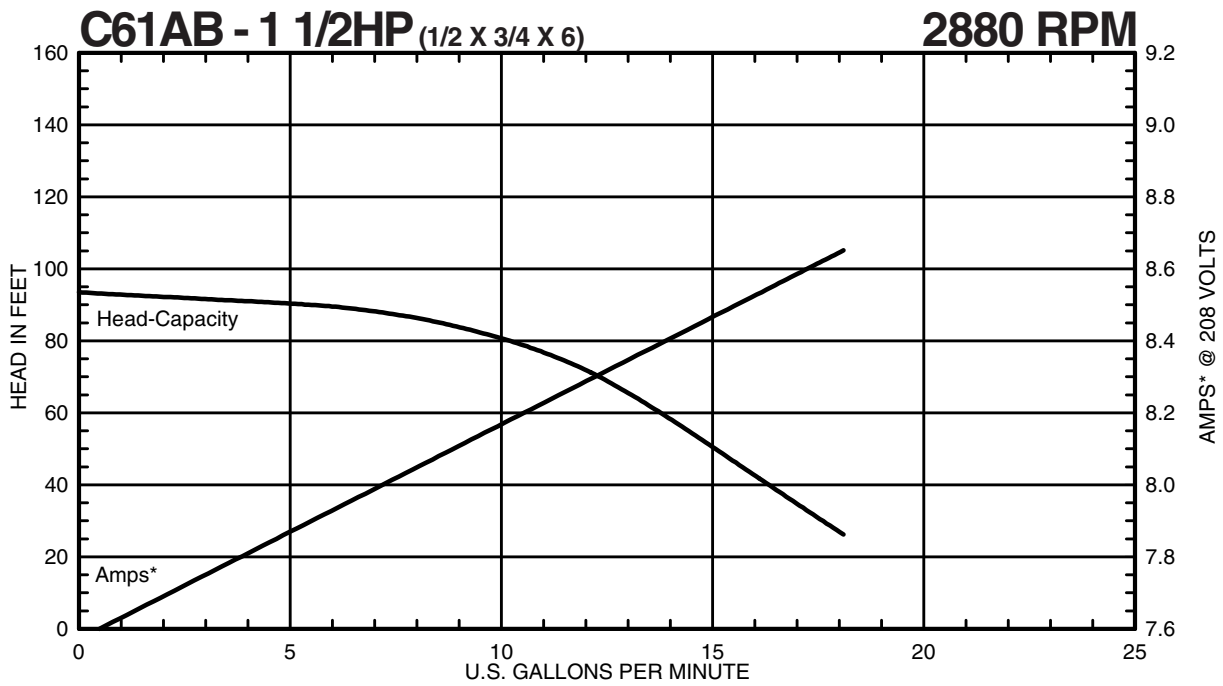
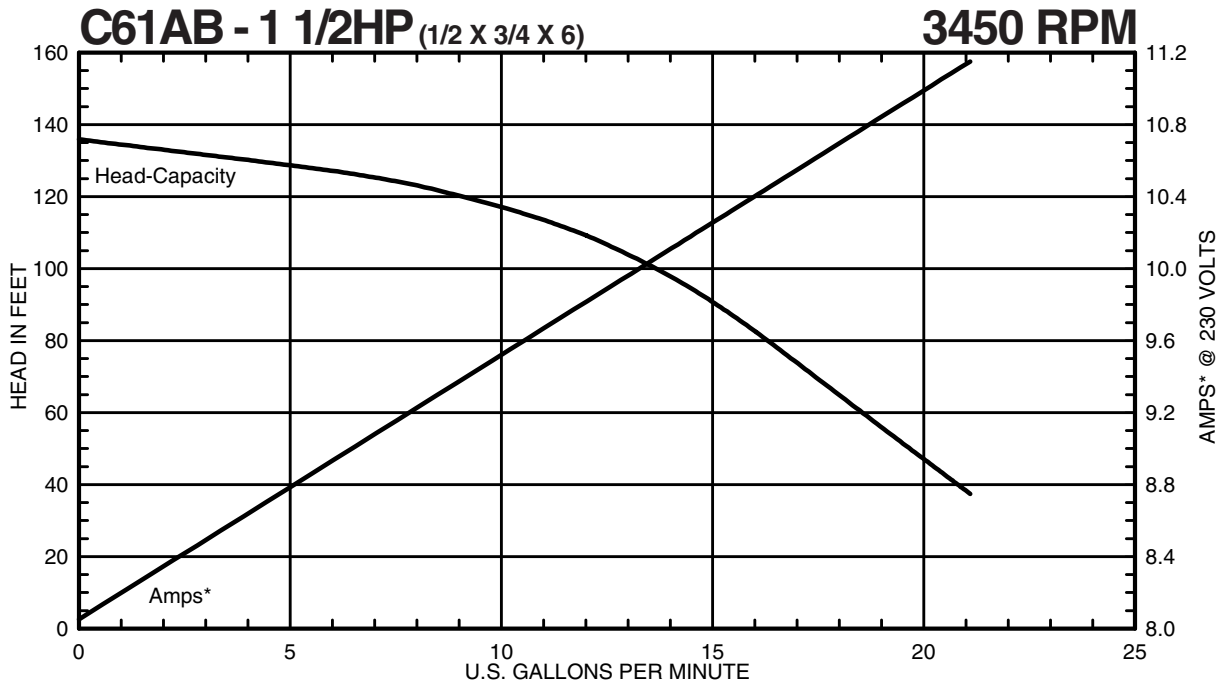

## MTH PUMPS

401 West Main Street • Plano, IL 60545-1436  
 Phone: 630-552-4115 • Fax: 630-552-3688  
 Email: SALES@MTHPUMPS.COM  
<http://WWW.MTHPUMPS.COM>

\*Amp and HP data valid for 1.0 specific gravity fluids only (1 Phase)

C41 • C51 • C61 SERIES

# Performance Curves (Single Phase)

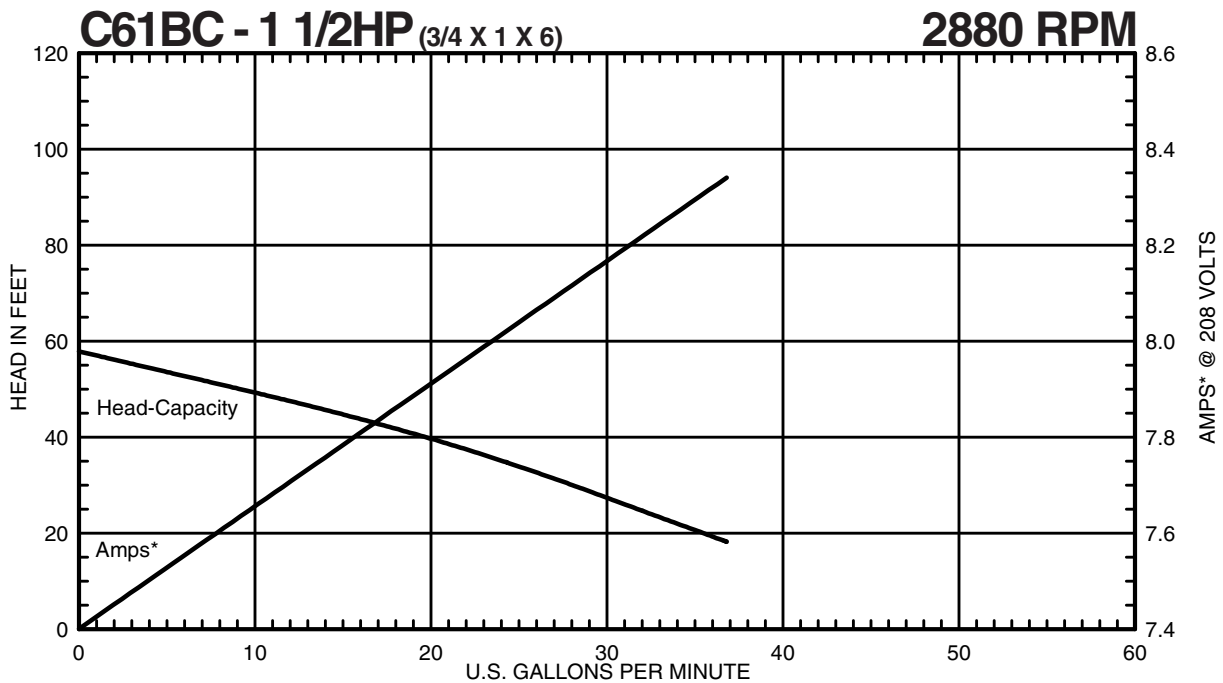
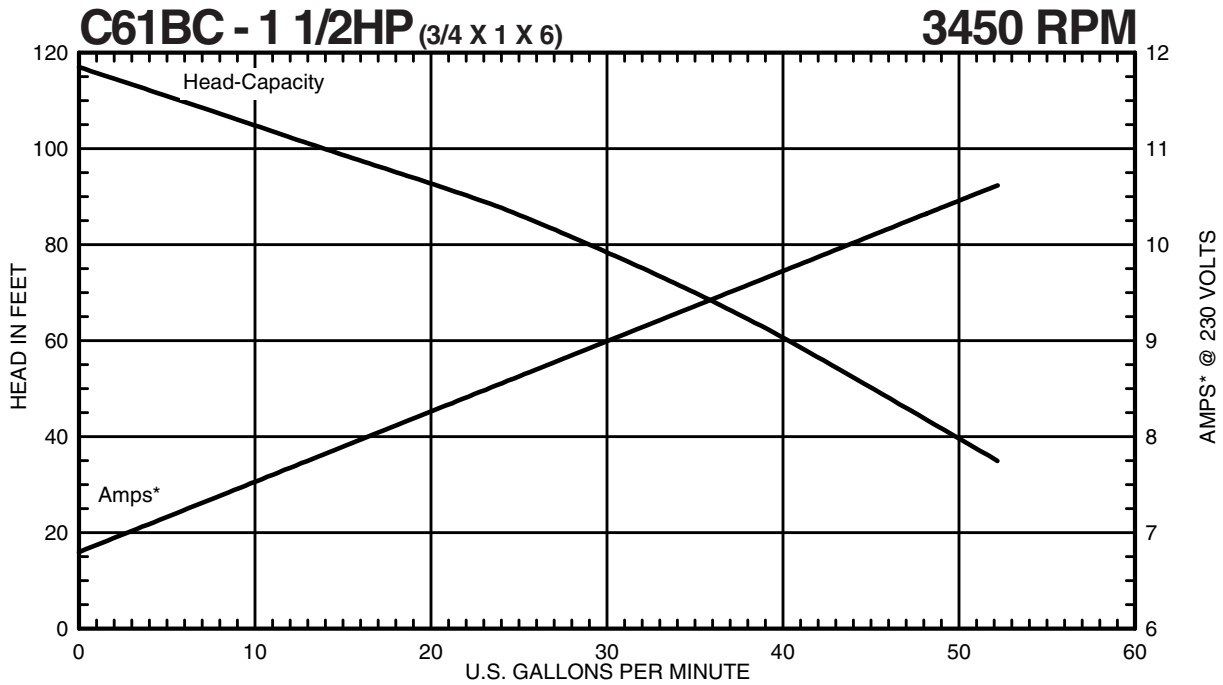

**MTH PUMPS**

401 West Main Street • Plano, IL 60545-1436  
Phone: 630-552-4115 • Fax: 630-552-3688  
Email: SALES@MTHPUMPS.COM  
<http://WWW.MTHPUMPS.COM>

\*Amp and HP data valid for 1.0 specific gravity fluids only (1 Phase)

# Performance Curves

(Single Phase)

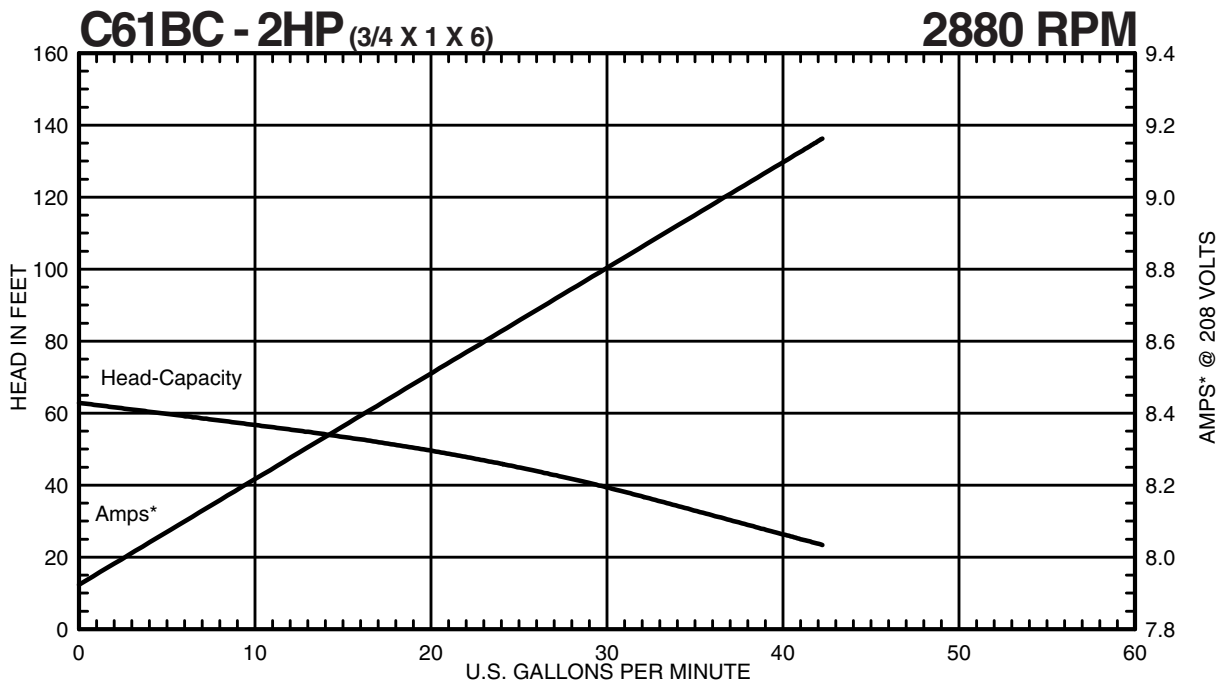
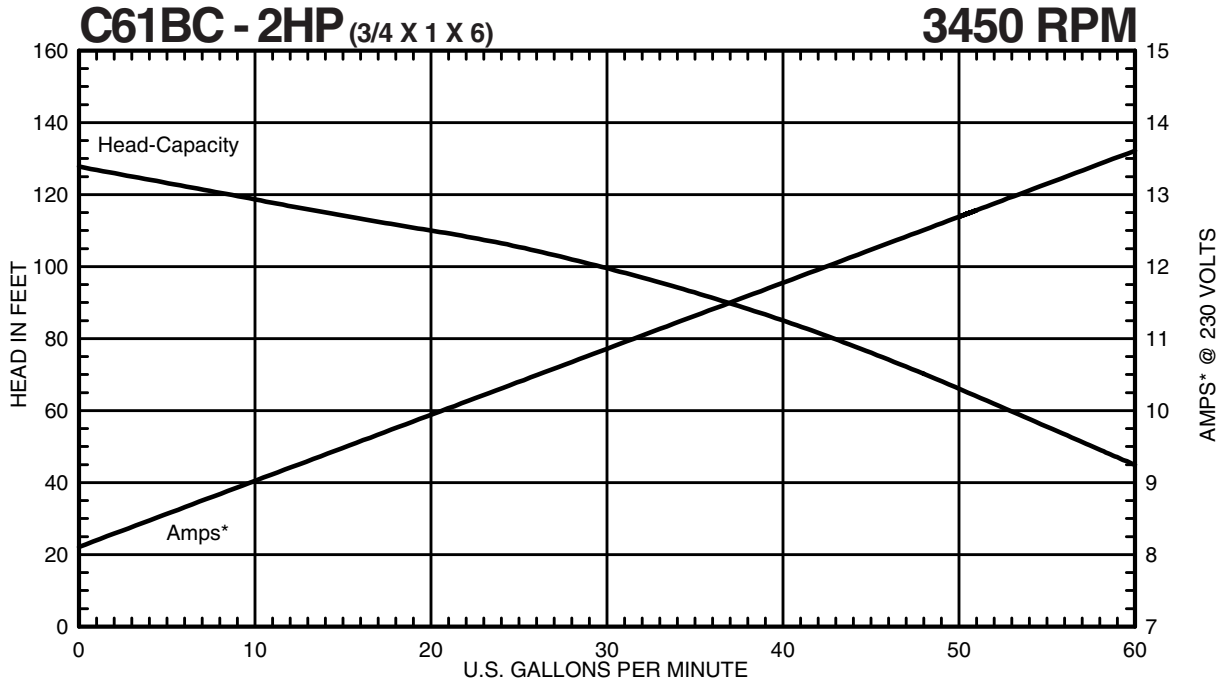

**MTH PUMPS**

401 West Main Street • Plano, IL 60545-1436  
 Phone: 630-552-4115 • Fax: 630-552-3688  
 Email: SALES@MTHPUMPS.COM  
<http://WWW.MTHPUMPS.COM>

\*Amp and HP data valid for 1.0 specific gravity fluids only (1 Phase)